

ABB MEASUREMENT & ANALYTICS | OPERATING INSTRUCTION

SensyMaster FMT430, FMT450

Thermal mass flowmeter



Measurement made easy

Further information

Additional documentation on SensyMaster FMT430, FMT450 is available for download free of charge at www.abb.com/flow.

Alternatively simply scan this code:



Short product description

Thermal Mass Flowmeter on the mass flow measurement of gases and gas mixtures in closed pipelines.

Device firmware version:

— 01.00.07 (HART)

Additional Information

Additional documentation on SensyMaster FMT430, FMT450 is available free of charge for downloading at www.abb.com/flow. Alternatively simply scan this code:

**Manufacturer**

ABB Automation Products GmbH

Measurement & Analytics

Dransfelder Str. 2

37079 Göttingen

Germany

Tel: +49 551 905-0

Fax: +49 551 905-777

Customer service center

Tel: +49 180 5 222 580

Mail: automation.service@de.abb.com

Contents

1	Safety	5
1.1	General information and instructions	5
1.2	Warnings.....	5
1.3	Intended use.....	5
1.4	Improper use	5
1.5	Notes on data security.....	6
1.6	Warranty provisions	6
2	Function and system design	7
2.1	Overview	7
2.1.1	Sensor	7
2.1.2	Transmitter	8
2.1.3	Process connections	9
2.2	Device description	10
2.3	Measuring principle.....	10
3	Product identification	11
3.1	Name plate.....	11
4	Transport and storage	11
4.1	Inspection	11
4.2	Transport.....	11
4.3	Storing the device.....	11
4.3.1	Ambient conditions.....	12
4.4	Returning devices	12
5	Installation	12
5.1	Installation conditions.....	13
5.1.1	Installation location and assembly.....	13
5.1.2	Inlet and outlet sections.....	13
5.1.3	Installation at high ambient temperatures....	14
5.1.4	Sensor insulation	14
5.2	Environmental conditions	14
5.2.1	Ambient temperature	14
5.2.2	NEMA rating.....	14
5.3	Process conditions.....	14
5.3.1	Measuring medium temperature.....	14
5.3.2	Material loads for process connections	15
5.4	Assembly of the pipe component.....	16
5.4.1	Wafer type design (FMT091) and partial measuring section (FMT092).....	16
5.4.2	Weld-on adapter	17
5.4.3	Integrated hot tap fitting.....	21
5.5	Installing the sensor	22
5.5.1	Wafer type design and welding adapter	22
5.5.2	Installation / Disassembly in connection with the changing device	23
5.6	Installing the transmitter in the remote mount design	24
5.7	Opening and closing the housing.....	25
5.7.1	Rotating the transmitter housing and LCD display.....	26
5.8	Installing the plug-in cards	28
5.9	Electrical connections.....	30
5.9.1	Connecting the power supply	30
5.9.2	Cable entries.....	31
5.9.3	Installing the connecting cables	31
5.9.4	Signal cable.....	31
5.9.5	Electrical connection (HART protocol).....	32
5.10	Electrical data for inputs and outputs.....	33
5.10.1	Connection examples	36
5.10.2	Connection to integral mount design.....	37
5.10.3	Connection to remote mount design	39
6	Commissioning	42
6.1	Safety instructions	42
6.2	Hardware settings.....	42
6.2.1	Dual-compartment housing	42
6.2.2	Single-compartment housing	43
6.3	Checks prior to commissioning.....	44
6.4	Parameterization of the device.....	44
6.4.1	Parameterization via the local operating interface	44
6.4.2	Parameterization via the infrared service port adapter	45
6.4.3	Parameterization via HART	45
6.5	Switching on the power supply.....	45
6.6	Parameterization via the "Easy Setup" menu function	46
7	Operation	51
7.1	Safety instructions	51
7.2	Menu navigation	51
7.3	Menu levels.....	52
7.3.1	Process display	53
7.3.2	Switching to the information level (operator menu).....	53
7.3.3	Error messages on the LCD display	54
7.3.4	Switching to the configuration level (parameterization)	54
7.3.5	Selecting and changing parameters	55
7.4	Parameter overview	57

7.5	Parameter descriptions	65
7.5.1	Available units.....	65
7.5.2	Available gas types	66
7.5.3	Available process variables	67
7.5.4	Menu: Easy Setup	68
7.5.5	Menu: Device Info	71
7.5.6	Menu: Device Setup	75
7.5.7	Menu: Display.....	80
7.5.8	Menu: Input/Output	81
7.5.9	Menu: Process Alarm	86
7.5.10	Menu: Communication	87
7.5.11	Menu: Diagnostics	88
7.5.12	Menu: Totalizer	90
7.6	Software history.....	91
7.7	FillMass batch function.....	92
7.7.1	Configuration	92
8	Diagnosis / error messages	93
8.1	Calling up the error description	93
8.2	General remarks	93
8.3	Overview	94
8.4	Error messages	96
9	Maintenance.....	99
9.1	Safety instructions	99
9.2	Flowmeter sensor	99
9.3	Cleaning	99
9.3.1	Clean measuring element.....	99
9.4	Integrated hot tap fitting.....	100
10	Repair.....	101
10.1	Safety instructions	101
10.2	Spare parts.....	101
10.3	Fuse replacement.....	101
10.4	Replacing the LCD indicator	102
10.5	Replacing the frontend board	103
10.5.1	Integral mount design.....	103
10.5.2	Remote mount design.....	105
10.6	Replacing the flowmeter sensor	106
10.7	Returning devices	106
11	Recycling and disposal	107
11.1	Dismounting	107
11.2	Disposal	107
12	Specification	107
13	Additional documents.....	107
14	Appendix.....	108
14.1	Return form.....	108

1 Safety

1.1 General information and instructions

These instructions are an important part of the product and must be retained for future reference.

Installation, commissioning, and maintenance of the product may only be performed by trained specialist personnel who have been authorized by the plant operator accordingly. The specialist personnel must have read and understood the manual and must comply with its instructions.

For additional information or if specific problems occur that are not discussed in these instructions, contact the manufacturer. The content of these instructions is neither part of nor an amendment to any previous or existing agreement, promise or legal relationship.

Modifications and repairs to the product may only be performed if expressly permitted by these instructions. Information and symbols on the product must be observed. These may not be removed and must be fully legible at all times. The operating company must strictly observe the applicable national regulations relating to the installation, function testing, repair and maintenance of electrical products.

1.2 Warnings

The warnings in these instructions are structured as follows:

DANGER

The signal word "DANGER" indicates an imminent danger. Failure to observe this information will result in death or severe injury.

WARNING

The signal word "WARNING" indicates an imminent danger. Failure to observe this information may result in death or severe injury.

CAUTION

The signal word "CAUTION" indicates an imminent danger. Failure to observe this information may result in minor or moderate injury.

NOTICE

The signal word "NOTICE" indicates useful or important information about the product. The signal word "NOTICE" is not a signal word indicating a danger to personnel. The signal word "NOTICE" can also refer to material damage.

1.3 Intended use

This device can be used in the following applications:

- As a plug-in sensor flanged into the pipe component in pipelines with nominal diameters DN 25 ... DN 200 (1 ... 8 in.).
- Through a welding adapter directly in pipelines of nominal diameter DN 100 (4 in.) and above, as well as for non-circular cross-sections.

This device is intended for the following uses:

- for direct mass flow measurement of gases and gas mixtures in closed pipelines.
- for indirect measurement of standard volume flows (through standard density and mass current).
- For measuring the temperature of the measuring medium.

The device has been designed for use exclusively within the technical limit values indicated on the identification plate and in the data sheets.

When using media for measurement the following points must be observed:

- Measuring media may only be used if, based on the state of the art or the operating experience of the user, it can be assured that the chemical and physical properties necessary for safe operation of the materials of flowmeter sensor components coming into contact with these will not be adversely affected during the operating period.
- Media containing chloride in particular can cause corrosion damage to stainless steels which, although not visible externally, can damage wetted parts beyond repair and lead to the measuring medium escaping. It is the operator's responsibility to check the suitability of these materials for the respective application.
- Measuring media with unknown properties or abrasive measuring media may only be used if the operator can perform regular and suitable tests to ensure the safe condition of the meter.

1.4 Improper use

The following are considered to be instances of improper use of the device:

- For operating as a flexible adapter in piping, e.g. for compensating pipe offsets, pipe vibrations, pipe expansions, etc.
- For use as a climbing aid, e.g. for mounting purposes
- For use as a support for external loads, e.g. as a support for piping, etc.
- Material application, e.g. by painting over the housing, name plate or welding/soldering on parts.
- Material removal, e.g. by spot drilling the housing.

1.5 Notes on data security

This product is designed to be connected to and to communicate information and data via a network interface.

It is operator's sole responsibility to provide and continuously ensure a secure connection between the product and your network or any other network (as the case may be).

Operator shall establish and maintain any appropriate measures (such as but not limited to the installation of firewalls, application of authentication measures, encryption of data, installation of anti-virus programs, etc.) to protect the product, the network, its system and the interface against any kind of security breaches, unauthorized access, interference, intrusion, leakage and / or theft of data or information.

ABB Automation Products GmbH and its affiliates are not liable for damages and / or losses related to such security breaches, any unauthorized access, interference, intrusion, leakage and / or theft of data or information.

1.6 Warranty provisions

Using the device in a manner that does not fall within the scope of its intended use, disregarding this manual, using underqualified personnel, or making unauthorized alterations releases the manufacturer from liability for any resulting damage. This renders the manufacturer's warranty null and void.

2 Function and system design

2.1 Overview

2.1.1 Sensor

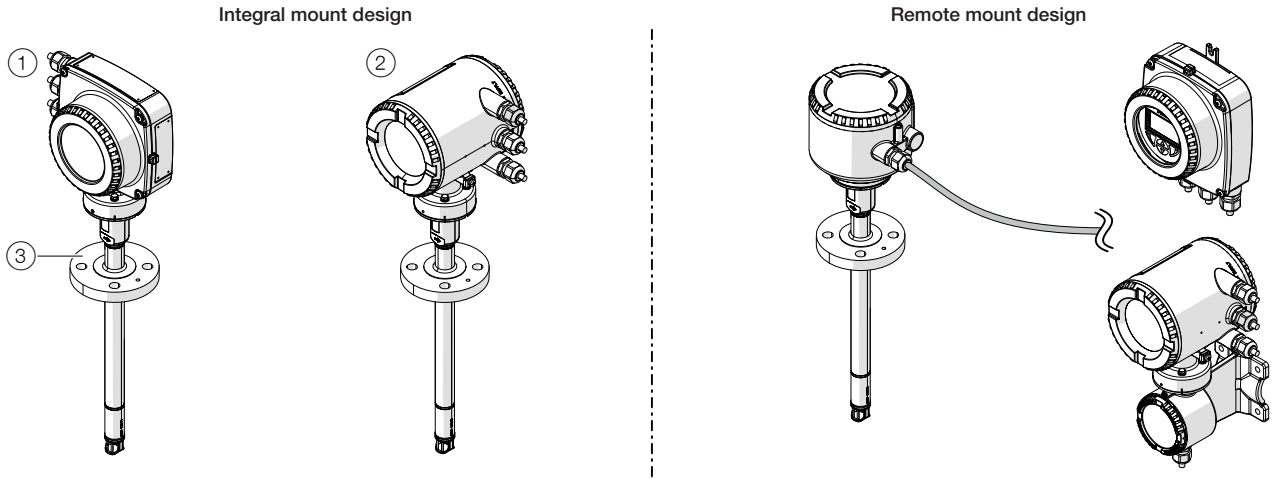

Fig. 1: Designs
 ① Single-compartment housing ② Dual-compartment housing ③ sensor connector

Model	FMT430	FMT450
Design	Integral mount design, remote mount design	
Measuring media	Gas (air ,methane, nitrogen, hydrogen, carbon dioxide, oxygen, natural gas, ammonia, helium, argon, propane, ethane, butane, ethene, biogas) and gas mixtures with known compositions	
Measuring accuracy for gases¹⁾ Air, nitrogen	$\pm 1.2\%$ of Q_m in the range of 10 ... 100% of the measuring range; $\pm 0.12\%$ of the Q_{maxDN} possible in the nominal diameter in the range of 0 ... 10 % of the measuring range	$\pm 0.6\%$ of the measured value, $\pm 0.05\%$ of the Q_{maxDN} possible in the nominal diameter
Other gases (optional process gas calibration)	–	$\pm 1.6\%$ of the measured value, $\pm 0.1\%$ of the Q_{maxDN} possible in the nominal diameter
Extended measuring range	No	Yes, optional
Measuring medium temperature T_{medium}	Standard: -25 ... 150 °C (-13 ... 302 °F)	Standard: -25 ... 150 °C (-13 ... 302 °F), optional: -25 ... 300 °C (-13 ... 572 °F)
Ambient temperature $T_{ambient}$	Standard: -20 ... 70 °C (-4 ... 158 °F), optional: -40 ... 70 °C (-40 ... 158 °F), -50 ... 70 °C (-58 ... 158 °F)	
Sensor connection	Flange DN 25 – PN 40, threaded connection DN 11851, compression fitting	
Wetted materials	Stainless steel, ceramic sensor (other materials on request)	
IP rating in accordance with EN 60529	IP 65 / IP 67	
NEMA rating	In accordance with NEMA 4X	
Approvals and certificates		
— Explosion protection ATEX / IECEx	In preparation	
— Explosion protection cFMus	In preparation	
— Further approvals	Available on our website abb.com/flow or on request	

1) The stated measuring accuracy only applies under the reference conditions in the stated measuring range.

2.1.2 Transmitter

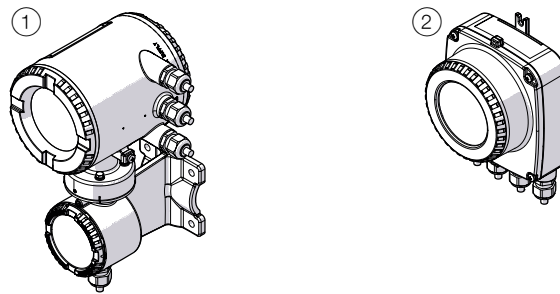

Fig. 2: Transmitter with remote mount design

① Dual-compartment housing ② Single-compartment housing

Model	FMT432	FMT452
Design	Integral mount design (see 'Fig. 1' on page 7), remote mount design.	
IP rating	In accordance with EN 60529: IP 65 / IP 67	
NEMA rating	In accordance with NEMA 4X	
Signal cable length	Maximum 200 m (656 ft), remote mount design only	
Power supply	100 ... 240 V AC (-15 / +10 %), 50 / 60 Hz, 24 V DC, ± 20 %	
Outputs in basic version	Current output: 4 ... 20 mA, active or passive Digital output 1: passive, configurable as pulse, frequency or switch output Digital output 2: passive, configurable as pulse, frequency or switch output	
Additional optional outputs	The transmitter has two slots in which plug-in cards can be inserted to provide additional inputs and outputs. The following expansion cards are available: — Current output (maximum two expansion cards simultaneously) — Digital output (maximum one expansion card) — Digital input (maximum two expansion cards) — 24 V DC power supply for active outputs (maximum one expansion card)	
Communication	Standard: HART 7.1, optional: PROFIBUS DP (in preparation) / Modbus (in preparation)	
External output zero return	Yes	
External totalizer reset	Yes	
Counter	Yes	
ApplicationSelector	Yes, up to 2 applications	Yes, up to 8 applications
Preconfigured applications	Yes, up to 2 applications	Yes, up to 4 applications
Customer-specific applications	No	Yes, up to 4 customer-specific applications
Selectable nominal diameters	Yes	Yes
Selectable gas type	No	Yes
Filling function	No	Yes, optional
"VeriMass" diagnosis function	Yes, optional	Yes, optional
Approvals		
— Further approvals	At www.abb.com/flow or on request.	

2.1.3 Process connections

FMT091 – Wafer type design

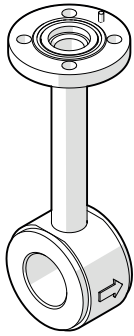

FMT094 – Weld-on adapter

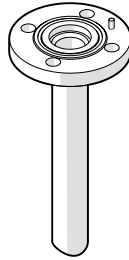

FMT094 – Weld-on adapter with clamp ring threading

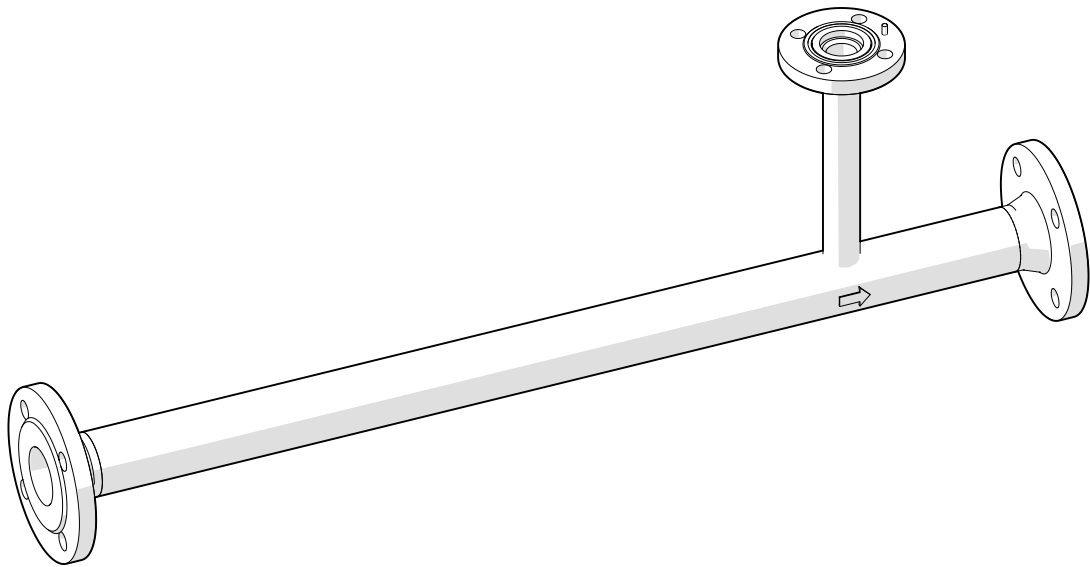

FMT092 – Partial measuring section

Fig. 3: Pipe components (examples)

Pipe components	
FMT091 – Wafer type design	In accordance with EN 092-1: DN 40 ... 200, PN 40 In accordance with ASME B16.5: 1 1/2 ... 8 in., CL 150 ... 300
FMT092 – Partial measuring section	Flange in accordance with EN 1092-1, DN 40 ... 100 (larger nominal diameters on request), PN 10 ... 40. Flange in accordance with ASME B16.5: 1 1/2 ... 8 in., CL 150 ... 300 Male thread DN 25 ... 80 R1 ... 3 in.
FMT094 – Weld-on adapter	For rectangular ducts or pipe diameters \geq DN 100 (4 in.), PN 16 ... 40
Wetted materials	Stainless steel, galvanized steel (other materials on request)

2.2 Device description

The SensyMaster FMT430, FMT450 works in accordance with the measuring principle of a hot-film anemometer. This measurement method allows for direct measurement of the gas mass flow.

Taking into account the standard density, the norm volume flow can be displayed without the need for additional pressure and temperature compensation.

The transmitter is equipped with an analog / HART output (0/4 ... 20 mA) and two fast digital outputs that can be configured as pulse, frequency or binary outputs.

Optionally, the transmitter can be extended using plug-in cards with further inputs and outputs.

The SensyMaster FMT430, FMT450 is used in the process industry for the flow measurement of gases and gas mixtures.

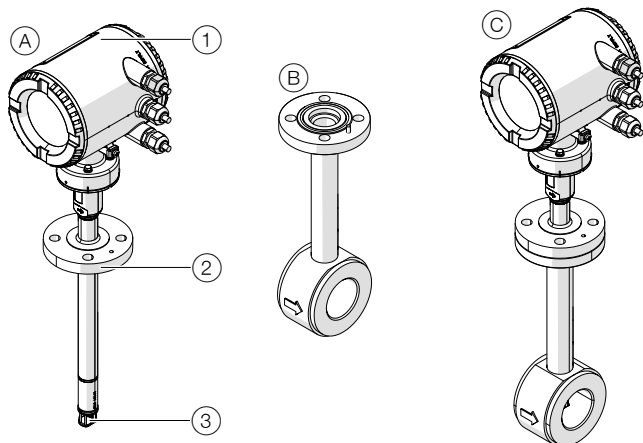

Fig. 4: Sensor (example, wafer type design)

(A) Sensor (B) Pipe component (C) Sensor with pipe component
 ① Transmitter ② Sensor connection ③ Thermal measuring element

The SensyMaster FMT430, FMT450 is composed of the components sensor and pipe component (process connection). The pipe component can be delivered in various designs. In addition, a weld-on adapter makes it possible to install the flowmeter sensor in rectangular ducts or pipelines with any diameter.

2.3 Measuring principle

Thermal flow metering procedures use different ways to evaluate the flow dependent cooling of a heated resistor as measuring signal.

In a hotfilm anemometer with constant temperature difference control, the heated platinum resistor is maintained at a constant overtemperature in relation to an unheated platinum sensor inside the gas flow.

The heating power required for maintaining the overtemperature depends directly on the flow rate and the material properties of the gas. With a known (and constant) gas composition the mass-flow can be determined by electronically evaluating the heater current / mass-flow curve without additional pressure and temperature compensation.

Together with the standard density of the gas this results directly in the standard volume flow.

Considering the high measuring range dynamics up to 1:100, an accuracy smaller than 1 % of the measuring value is achieved.

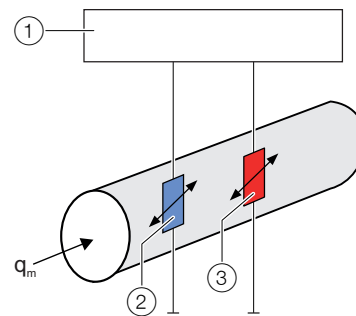

Fig. 5: Measuring principle (simplified)

① Transmitter ② Measurement resistor gas temperature ③ Heat resistor

The transmitter has three signals available. In addition to the heating power, the temperatures of the measuring medium and the heater resistance are included herein, which can be used to compensate the temperature dependency of gas parameters. By storing the gas data in the transmitter the optimal tailoring can be calculated and performed at any operating point.

3 Product identification

3.1 Name plate

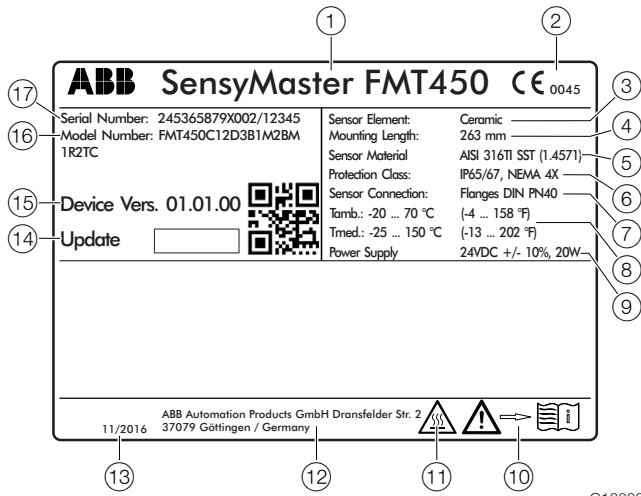

Fig. 6: Name plate (example)

- ① Type designation ② CE mark ③ Measuring element design
 ④ Sensor installation length ⑤ Wetted material ⑥ IP / NEMA protection type ⑦ Sensor process connection ⑧ Ambient temperature / model number range (T_{amb.} / T_{med.}) ⑨ Power supply
 ⑩ "Read operating instruction" symbol ⑪ "Hot surface" symbol
 ⑫ Manufacturer address ⑬ Manufacture date (month / year)
 ⑭ Update field device firmware ⑮ Device firmware revision
 ⑯ Order code ⑰ Serial number

4 Transport and storage

4.1 Inspection

Check the devices immediately after unpacking for possible damage that may have occurred from improper transport. Details of any damage that has occurred in transit must be recorded on the transport documents. All claims for damages must be submitted to the shipper without delay and before installation.

4.2 Transport

⚠ DANGER

Life-threatening danger due to suspended loads. In the case of suspended loads, a danger of the load falling exists. Remaining under suspended loads is prohibited.

⚠ WARNING

Risk of injury due to device slipping. The device's center of gravity may be higher than the harness suspension points.

- Make sure that the device does not slip or turn during transport.
- Support the device laterally during transport.

4.3 Storing the device

Bear the following points in mind when storing devices:

- Store the device in its original packaging in a dry and dust-free location.
- Observe the permitted ambient conditions for transport and storage.
- Avoid storing the device in direct sunlight.
- In principle, the devices may be stored for an unlimited period. However, the warranty conditions stipulated in the order confirmation of the supplier apply.

Observe the following instructions:

- Do not expose the device to humidity during transport. Pack the device accordingly.
- Pack the device so that it is protected against vibrations during transport, e.g., by using air-cushioned packaging.

If the original packaging material is no longer available, wrap the device in bubble wrap or corrugated cardboard and place it in a box of sufficient size lined with a shock-absorbing material (e.g., foam rubber). The thickness of the padding should be appropriate for the device weight and type of shipment. The box must be labeled as “fragile”.

For overseas shipment, always add a desiccant (e.g., silica gel) and hermetically seal the device plus desiccant in a layer of polythene that is 0.2 mm thick. Use an amount of desiccant that is appropriate for the packing volume and the expected transport time (at least for three months). You should also line the box with a layer of union paper.

4.3.1 Ambient conditions

Storage temperature range

-25 ... 85 °C (-13 ... 185 °F)

Relative humidity

Maximum 85 % RH, annual average ≤ 65 % RH

4.4 Returning devices

For the return of devices, follow the instructions in the chapter ‘Repair’ on page 101.

5 Installation

DANGER

Danger to life due to piping under pressure!

Sensors which may eject during installation or removal in piping remaining under pressure may pose a danger to life.

- Install or remove a sensor only if the piping is depressurized.
- As an alternative, use a pipe component with an integrated replacement device.

WARNING

Risk of injury due to process conditions.

The process conditions, e.g. high pressures and temperatures, toxic and aggressive measuring media, can give rise to hazards when working on the device.

- Before working on the device, ensure that the process conditions do not pose any safety risks.
- If necessary, wear suitable personal protective equipment when working on the device.
- Depressurize and empty the device / piping, allow to cool and purge if necessary.

5.1 Installation conditions

5.1.1 Installation location and assembly

Note the following points when selecting the installation location and when mounting the sensor:

- The ambient conditions (IP rating, ambient temperature range T_{amb}) of the device must be adhered to at the installation location.
- Sensors and transmitters must not be exposed to direct sunlight. If necessary, provide a suitable means of sun protection on site. The limit values for the ambient temperature T_{amb} must be observed.
- On flange devices, ensure that the counterflanges of the piping are aligned plane parallel. Only install flange devices with suitable gaskets.
- Prevent the sensor from coming into contact with other objects.
- The device is designed for industrial applications. No special EMC protective measures are required if the electromagnetic fields and interference at the installation location of the device comply with "Best Practice" guidelines (in accordance with the standards referred to in the declaration of conformity). Maintain a suitable distance from electromagnetic fields and interference that extend beyond the usual dimensions.

Gaskets

Users are responsible for selecting and mounting suitable gaskets (material, shape).

Note the following points when selecting and mounting gaskets:

- Only gaskets made from a material that is compatible with the measuring medium and measuring medium temperature may be used
- Gaskets must not extend into the flow area, since possible turbulence may influence the accuracy of the device.

5.1.2 Inlet and outlet sections

The figures below show the recommended inlet and outlet sections for various installations.

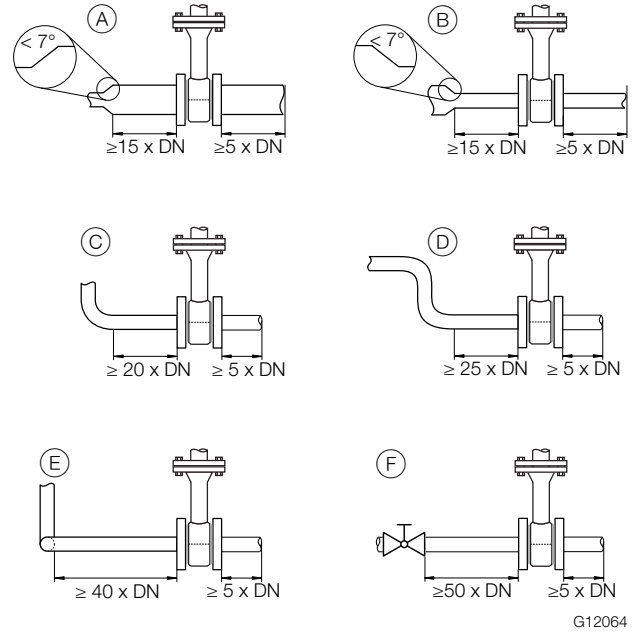

Fig. 7: Inlet and outlet sections G12064

Installation	Inlet section	Outlet section
(A) Pipe extension	min. 15 x DN	min. 5 x DN
(B) Pipe reduction	min. 15 x DN	
(C) 90° Pipe elbow	min. 20 x DN	
(D) 2 x 90° Pipe elbow in one level	min. 25 x DN	
(E) 2 x 90° Pipe elbow in two levels	min. 40 x DN	
(F) Turn-off device	min. 50 x DN	

To achieve the specified measuring accuracy, the indicated inlet and outlet sections are required.

In case of combinations of several inlet-side errors, e.g. valve and reduction, a longer inlet section must always be taken into account.

In case of confined spaces at the installation place, the outlet section can be reduced to 3 x DN. However, reducing the specified inlet section will reduce the achievable level of accuracy.

A high repeatability of the measured value is maintained.

In case of insufficient inlet and outlet sections, a special calibration may be possible. To do this, a detailed alignment is necessary for individual cases.

The specified inlet and outlet sections must be doubled for gases with a very low density (hydrogen, helium).

5.1.3 Installation at high ambient temperatures

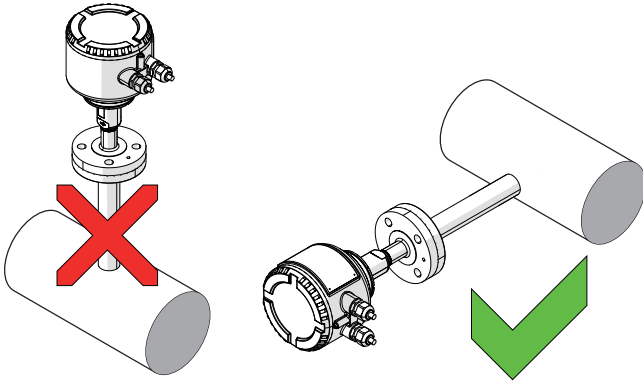

Fig. 8: Mounting position at high ambient temperatures

Under high but permissible ambient temperatures, avoid additional thermal stress from heat convection or radiation, since these sources of heat may exceed the permissible ambient temperature on the equipment surface. If the device needs to be installed directly on a hot, horizontal piping, we recommend installing it on the side. In such cases, you should avoid installing it in the 12 o'clock position, otherwise the warm air that rises up will cause additional heating of the electronics.

5.1.4 Sensor insulation

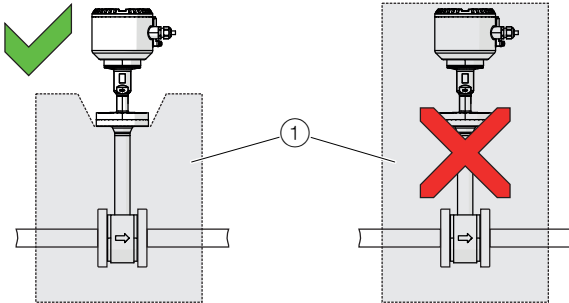

Fig. 9: Insulation of the sensor

① Insulation

The sensor may be insulated as shown in Fig. 9.

5.2 Environmental conditions

5.2.1 Ambient temperature

- Standard: -20 ... 70 °C (-4 ... 158 °F)
- Extended TA9: -40 ... 70 °C (-40 ... 158 °F)
- Extended TA6: -50 ... 70 °C (-58 ... 158 °F)

Relative humidity

Maximum 85 % RH, annual average ≤ 65 % RH

IP rating

In accordance with EN 60529: IP 65 / IP 67

5.2.2 NEMA rating

NEMA 4X

5.3 Process conditions

5.3.1 Measuring medium temperature

Devices with ceramic element and flange connection

- Standard: -25 ... 150 °C (-13 ... 302 °F)
- Extended (optional, only FMTx50):
-25 ... 300 °C (-13 ... 572 °F)

The approved measuring medium temperature T_{medium} also depends on the selected sensor process connection and the design of the pipe components.

The following temperature specifications apply:

Sensor connection	T_{medium}
Threaded connection DIN 11851	-40 ... 140 °C (-40 ... 284 °F)
Clamp ring fitting	-25 ... 140 °C (-13 ... 284 °F)
Pipe components with ball valve	Maximum 150 °C (302 °F)
Integrated hot tap fitting	See the chapter titled 'Material loads for process connections' on page 15

Maximum operating pressure

Standard for devices with flange connection, P_{medium} :
4 MPa, 40 bar (580 psi)

The approved operating pressure P_{medium} also depends on the selected sensor process connection and the design of the pipe components.

The following temperature specifications apply:

Sensor connection	P_{medium}
Threaded connection DIN 11851	1.6 MPa, 16 bar (232 psi)
Clamp ring fitting	2 MPa, 20 bar (290 psi)
Integrated hot tap fitting	See the chapter titled 'Material loads for process connections' on page 15

Pressure drop

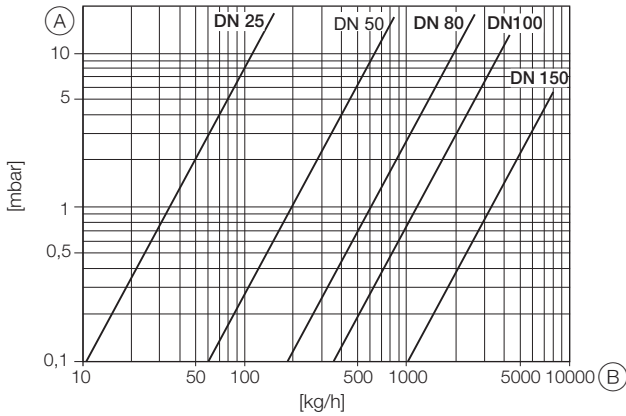

Fig. 10: Pressure loss in logarithmic representation
 (A) Pressure loss (B) Mass flow

5.3.2 Material loads for process connections
DIN and ASME flanges

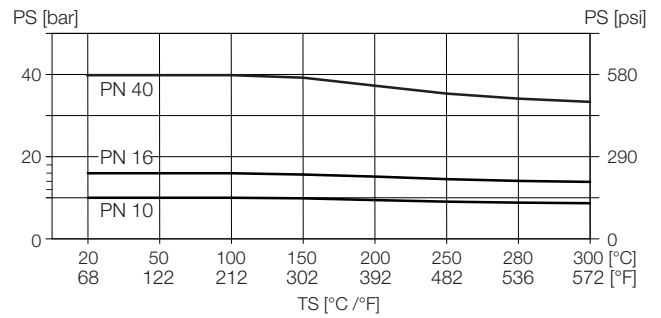

Fig. 11: DIN flange process connection

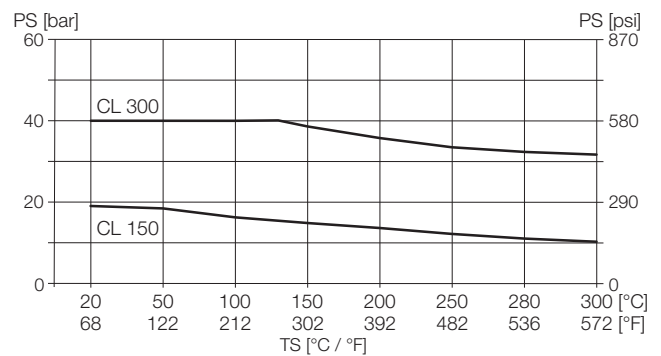

Fig. 12: ASME flange process connection

The maximum approved operating pressure for CL 300 is limited to 40 bar (580 psi).

Integrated hot tap fitting

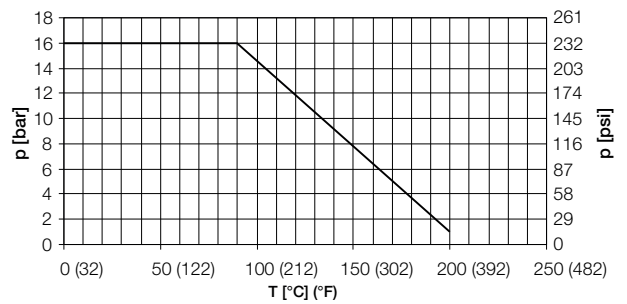

Fig. 13: Maximum pressure / temperature values for integrated hot tap fitting

5.4 Assembly of the pipe component

When installing the pipe components, observe the following points:

- During installation, it is important to ensure that the flow direction corresponds to the attached label.
- When welding the welding adapter, remember to observe the relevant welding instructions. The amount of heat introduced must be kept to an absolute minimum to prevent warping of the mounting flange's sealing surface.
- In the case of flanged connections, flat gaskets must be installed, which should be in perfect condition and resistant to the measuring media.
- Before installing pipe components or sensors, check all components and gaskets for damage.
- Pipe components must not be installed under tension, otherwise the pipeline may exert impermissible forces on the device.
- When assembling the flanged connections, use screws that offer the required strength and dimensions.
- The screws must be tightened evenly and to the required torque.
- Once the pipe components have been installed, the insertion connection must be sealed by means of a blind flange plus gasket or by closing a shut-off device (if present).

5.4.1 Wafer type design (FMT091) and partial measuring section (FMT092)

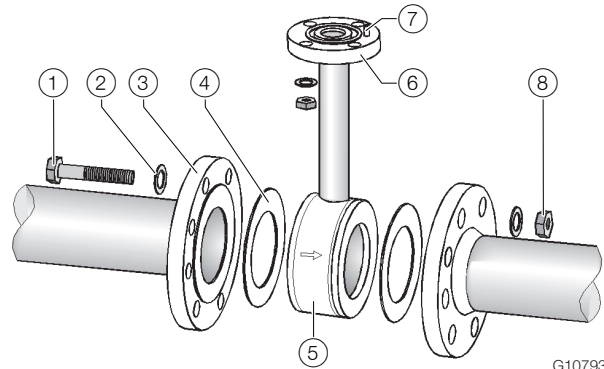

G10793

Fig. 14: Installing a pipe component (example, wafer type design)
 ① Flange screw ② Washer ③ Flange ④ Flange gasket ⑤ Pipe component ⑥ Sensor connection flange ⑦ Centering pin, outflow side ⑧ Nut

Installation of the FMT091 pipe component (wafer type design) and FMT092 (partial measuring section).

1. Position the pipe component coplanar and centered between the piping. The flow direction must correspond to the arrow indicated on the pipe component. The centering pin on the pipe component must be located on the outflow side (behind the measuring point).
2. Install gaskets between the sealing surfaces.

i NOTICE

For achieve the best measurement results, make sure the gaskets fit concentrically with the pipe component.

- The inside diameter of the pipe and flange must precisely match in the wafer type design. Any differences in levels or edges, or untidy weld seams, will reduce the measuring accuracy.
- To guarantee that the flow profile is not distorted, the gaskets must not protrude into the piping.

3. Use the appropriate screws for the holes.
4. Slightly grease the threaded nuts.
5. Tighten the nuts in a crosswise manner as shown in the figure. First tighten the nuts to approx. 50 % of the maximum torque, then to 80 %, and finally a third time to the maximum torque.

i NOTICE

Torques for screws depend on temperature, pressure, screw and gasket materials. The relevant applicable regulations must be taken into consideration.

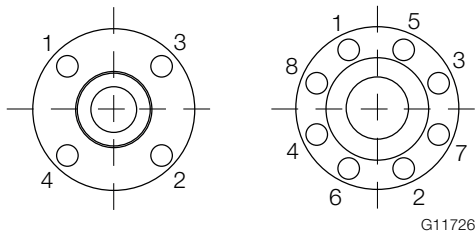

Fig. 15: Tightening sequence for the flange screws

5.4.2 Weld-on adapter

Consider the following points when installing the welding dater in the piping:

- After welding, the welding adapter must have a length of L (see chapter 'Mounting dimensions – welding adapter with flange and with and without ball valve' on page 19 and 'Assembly dimension - welding adapter with threaded connection in accordance with DIN 11851' on page 20).

$$L = h - (1/2 \times D)$$

L Length of the welding adapter

h Installation length of the sensor

D Outside diameter of the pipeline

- Shorten the length of the welding adapter as needed before welding it on. After welding, the welding adapter may protrude into the piping no more than 10 mm (0.39 inch).
- Observe thickness of pipeline wall and degree of shrinkage when welding!
- The distance h from the upper edge of the adapter flange to the pipe central axis must be within a tolerance of ± 2 mm (0.08 inch).
- Maintain a right angle to the pipe axis (max. tolerance 2°).
- The adapter centering pin must be aligned with the pipe axis in the flow direction (outflow side, behind the measuring point).
- Once welding is complete, there must be free clearance of at least 28 mm (1.10 inch) to install the sensor; drill to create clearance as needed.

Additional instructions for welding adapter with ball valve**⚠ DANGER****Danger to life due to improper installation!**

During welding, the gaskets in the ball valve may overheat. This can lead to the measuring medium escaping in an uncontrolled manner. This can result in severe injuries or death.

Remove the ball valve before welding.

Versions featuring a ball valve enable the flowmeter sensor to be installed and disassembled at low gauge pressures in the pipeline with minimal gas leakage.

The design with ball valve is installed as described above, but the following indications must be observed in addition:

- To install the sensor, the ball valve must be opened completely. Then, the flowmeter sensor can be installed along with the appropriate gasket and screwed into place.
- Before disassembling the sensor, make sure that the pipeline has been depressurized. Then, you can release the screws on the flange, remove the flowmeter sensor and close the ball valve.

i NOTICE**Damage to the sensor.**

Closing the ball valve before you remove the sensor can seriously damage the protective cage or the sensor elements. Do not close the ball valve until the flowmeter sensor has been removed.

Mounting dimensions – welding adapter with flange and with and without ball valve

Without ball valve

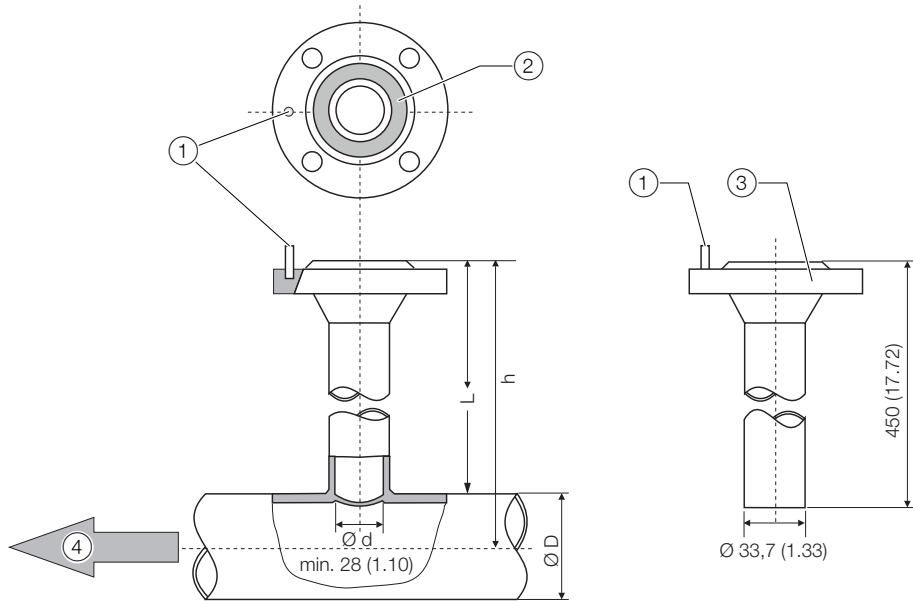

With ball valve

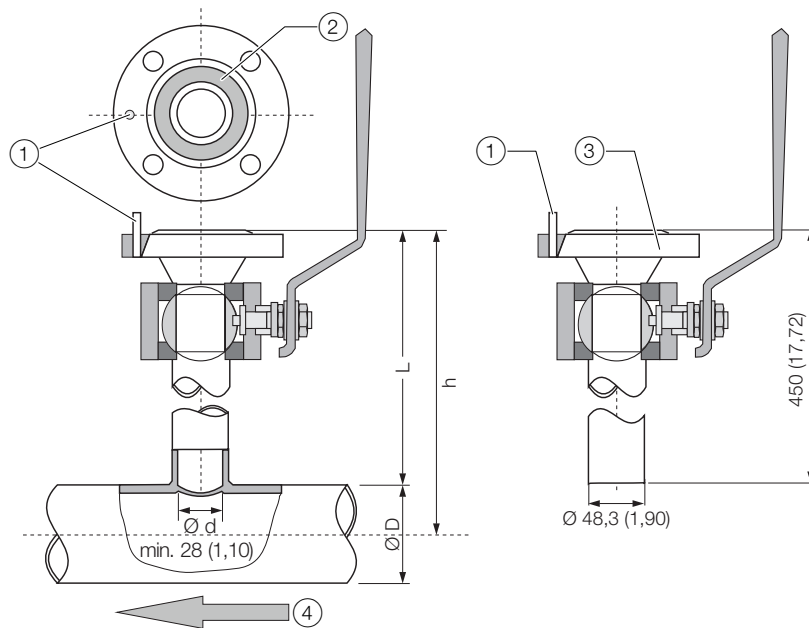
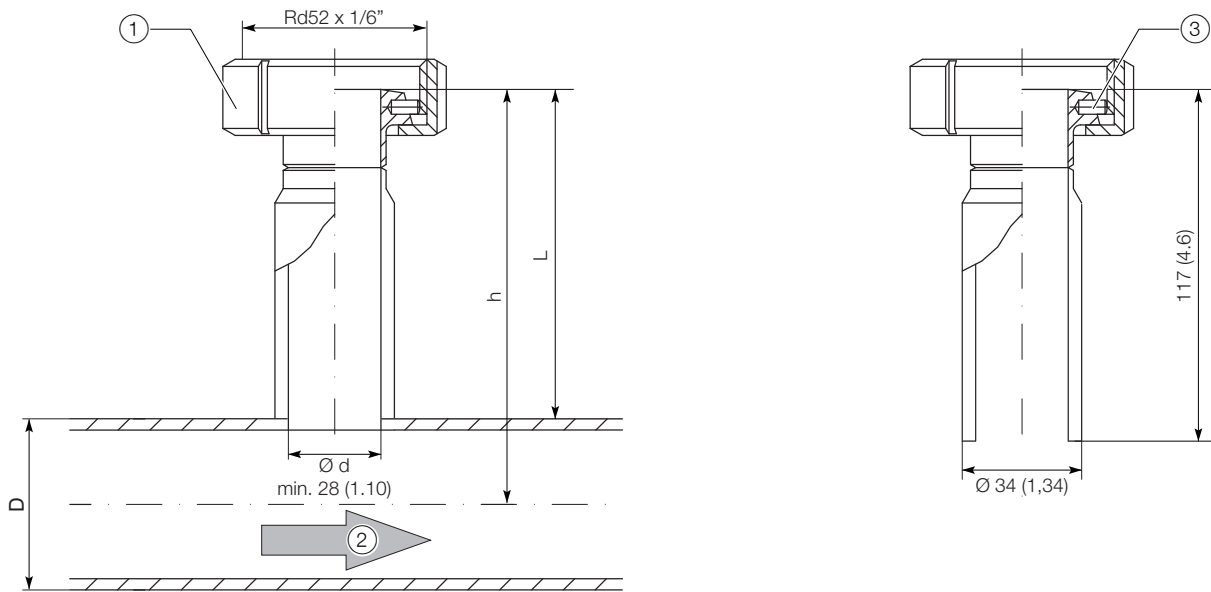

Fig. 16: Welding adapter with flange - all dimensions given in mm (inch).

① Centering pin ② Nut for O-ring ③ connection flange DN 25 (1") ④ flow direction

h – sensor length	Ø D – outer pipe diameter (min. / max.)	
	Without ball valve	With ball valve
263 (10.35)	100 ... 350 (3.94 ... 13.78)	100 ... 150 (3.94 ... 5.91)
425 (16.73)	> 350 ... 700 (> 13.78 ... 27.56)	> 150 ... 500 (> 5.91 ... 19.69)
775 (30.51)	> 700 ... 1400 (> 27.56 ... 55.12) ¹⁾	> 500 ... 1150 (> 19.69 ... 45.28) ¹⁾

1) The limitation of the maximum pipe diameter only applies for installations with a measuring element in the middle of the pipe. In case of larger or non-round cross-sections, a non-centered position of the measuring element in the piping is considered in the calibration.

Assembly dimension - welding adapter with threaded connection in accordance with DIN 11851**Fig. 17: Dimensions in mm (inch)****① Union nut ② Flow direction ③ Centering pin**

5.4.3 Integrated hot tap fitting

Wafer type design

Installation of the wafer type design is performed as explained in chapter 'Wafer type design (FMT091) and partial measuring section (FMT092)' on page 16.

Welding design

⚠ DANGER

Danger to life due to improper installation!

Do not shorten hot tap fitting components or interfere with the design. This can lead to the measuring medium escaping in an uncontrolled manner. This can result in severe injuries or death.

The welding version of the integrated changing device is available in two installation lengths:

- for nominal diameters DN 100 ... DN 125 (4 ... 5") and
- for nominal diameters DN 150 ... DN 300 (6 ... 12")

i NOTICE

- The sensor length *h* is 425 mm (16.73 inch) respectively.
- The installation depth *Y* depends on the pipe diameter and must be calculated individually.

Calculation of the outside length *X* and installation depth *Y*

$$X = h - (D/2)$$

$$Y = (D/2) - 28 \text{ mm (1.1 inch)}$$

- X* Outside length of the integrated changing device
- Y* Installation depth of the integrated changing device
- h* Sensor length
- D* Outside diameter of the pipeline

Example

- Sensor length *h* = 425 mm (16.73 inch)
- Pipe with external diameter of 210 mm (8.27 inch)
- The changing device is in measurement position

$$X = 425 \text{ mm} - (210 \text{ mm} / 2) = 320 \text{ mm}$$

$$Y = (210 \text{ mm} / 2) - 28 \text{ mm} = 77 \text{ mm}$$

Consider the following points when installing the welding version in the piping:

- Maintain a right angle to the pipe axis (max. tolerance 2°).
- The adapter centering pin must be aligned with the pipe axis in the flow direction (outflow side, behind the measuring point).

i NOTICE

Damage to components

If the welded joints become hot, warping of the sealing surfaces and / or damage to the O-rings can occur. Pause occasionally to allow the fitting to cool.

i NOTICE

Impact on measuring accuracy

Deviations from the stated dimension and position tolerances have an impact on measuring accuracy.

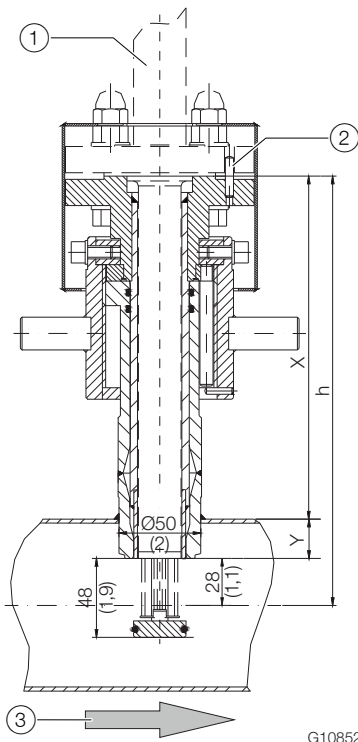

Fig. 18: Integrated changing device in measurement position, dimensions in mm (inch)

- ① Sensor ② Centering pin ③ Flow direction

5.5 Installing the sensor

When installing the sensor, observe the following points:

- Installation in the pipe component or welding adapter is only possible if the sensor data matches the measuring point specifications.
- The sensor may be sealed only by using the O-ring supplied in the scope of delivery. The O-ring must be placed in the designated groove on the sensor connection flange.
- The measuring elements may not be damaged when inserting the sensor into the pipe component.
- If you are using an integrated changing device, you must check that the changing device is in the disassembly position before releasing the mounting screws.

5.5.1 Wafer type design and welding adapter

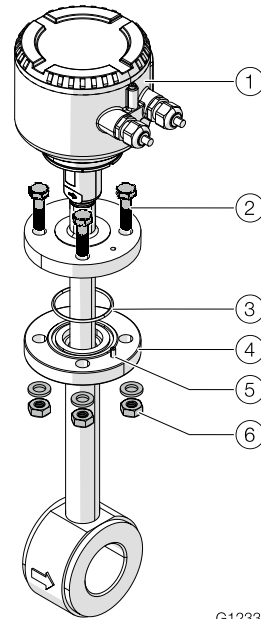

G12331

Fig. 19: Installing a sensor (example)

① Sensor ② Flange screws ③ O-Ring ④ Sensor connection flange
⑤ Centering pin ⑥ Washers and nuts

Installing the sensor:

1. Place the supplied O-ring in the groove of the sensor connection flange.
2. Carefully slide the sensor into the pipe component. Observe correct alignment to the centering pin in the process
3. Fasten the sensor to the sensor connection flange using screws. Tighten the flange screws simultaneously by applying the required torque (torque for supplied screws, non-lubricated, without use of spring washers: 87 Nm).

5.5.2 Installation / Disassembly in connection with the changing device

⚠ DANGER

Danger to life due to piping under pressure!

If the changing device is in the measurement position during disassembly of the sensor, this may pose a danger to life due to the possibility of the sensor being ejected.

Disassemble the sensor only if the changing device is in the disassemble position.

⚠ DANGER

Danger to life due to leaking measuring medium!

If the changing device is in the measurement position during disassembly of the sensor or gaskets in the changing device are damaged, leaking measuring medium may pose a danger to life.

- Make sure that the changing device is in the disassemble position.
- If measuring medium should start to leak in spite of this, immediately stop disassembly of the sensor and tighten the fastening screws.
- Drain and rinse the piping before disassembling the sensor, check and repair the changing device.

⚠ CAUTION

Risk of injury due to leaking measuring medium!

When you disassemble the transmitter, small quantities of measuring medium may leak due to the nature of the design. Make sure that sufficient ventilation is ensured during disassembly of the sensor.

i NOTICE

Damage to the changing device

Using tools or other devices to operate the lock nut can damage the hot tap fitting.

Only ever operate the lock nut manually.

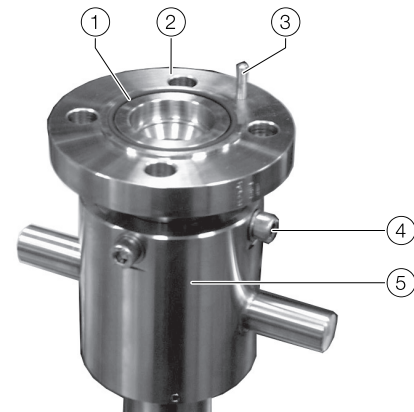

G10853

Fig. 20: Sensor process connection

① O-Ring ② Connection flange ③ Centering pin ④ Screws to secure the guiding pipe ⑤ union nut

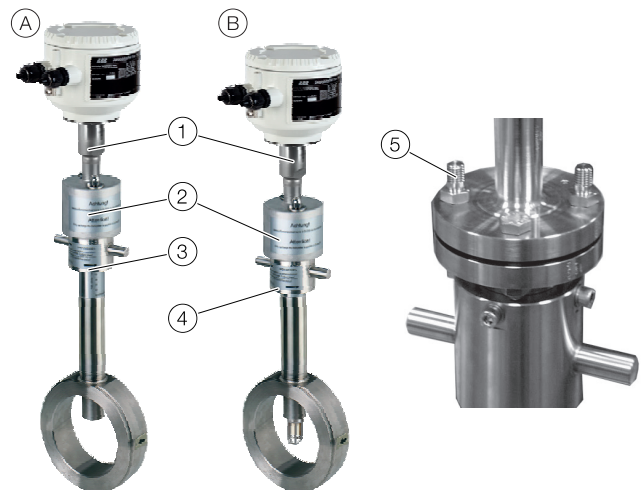

G10854

Fig. 21: Sensor Installation / Disassembly

Ⓐ Integrated changing device in disassemble position Ⓑ integrated changing device in measurement position

① Sensor ② Protection cap ③ Union nut in disassemble position ④ Union nut in measurement position ⑤ Special screws for protection cap

Installation of the sensor during operation

NOTICE

The changing device must be in the disassemble position before disassembling the sensor, the sensor process connection is sealed.

Installing the sensor:

1. Place the supplied O-ring in the groove of the sensor connection flange.
2. Carefully slide the sensor into the changing device. Observe correct alignment to the centering pin in the process.
3. Fasten the sensor to the sensor connection flange using screws. Use the supplied M12 screws, as well as two extended special screws for this.
4. Place the protection caps onto the special screws and tighten using two nuts.
5. Twist the transmitter with the union nut into the measuring position. The lower edge of the union nut indicates the position of the sensor. Only when the measuring position is reached 50 - OPEN - MESSEN (the lower limit stop of the union nut) will the sensor be in the middle of the piping and precise values can be provided.
6. Carry out the electrical connection

Disassembly of the sensor during operation

Disassembly of the sensor:

1. Twist the transmitter with the union nut into the disassemble position. The lower edge of the union nut indicates the position of the sensor. Only when the disassemble position is reached 0 - CLOSE - ZU (the upper limit stop of the union nut) will the sensor be in the disassemble position and the changing device is sealed off from the process.
2. Disconnect electrical connections.
3. Remove protection caps.
4. Remove flange screws.
5. Carefully pull the sensor out of the changing device (do not tip to the side).

5.6 Installing the transmitter in the remote mount design

When selecting a location for the transmitter, consider the following points:

- Observe the information concerning maximum ambient temperature and the protection class on the name plate.
- The location must be mostly free from vibration.
- The location must not be exposed to direct sunlight. If necessary provide a sun screen on site.
- Do not exceed the maximum signal cable length between the transmitter and the sensor.

1. Drill mounting holes at mounting location.
2. Attach transmitter securely to the mounting location using appropriate fasteners for the base material.

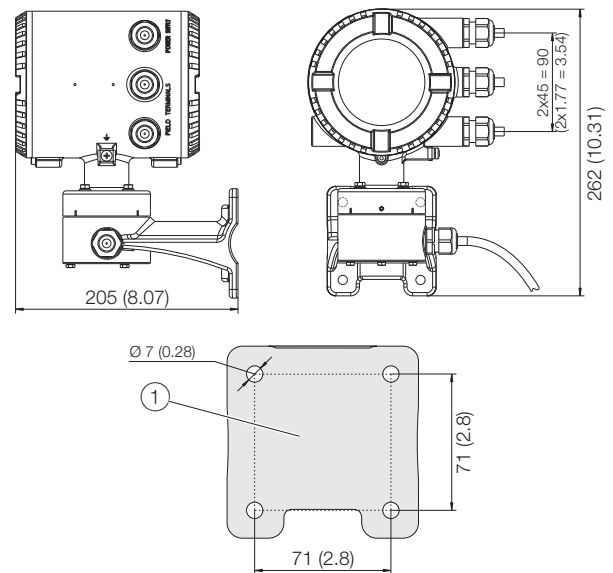

G11567

Fig. 22: Mounting dimensions of double-compartment housing

① Hole pattern for mounting holes

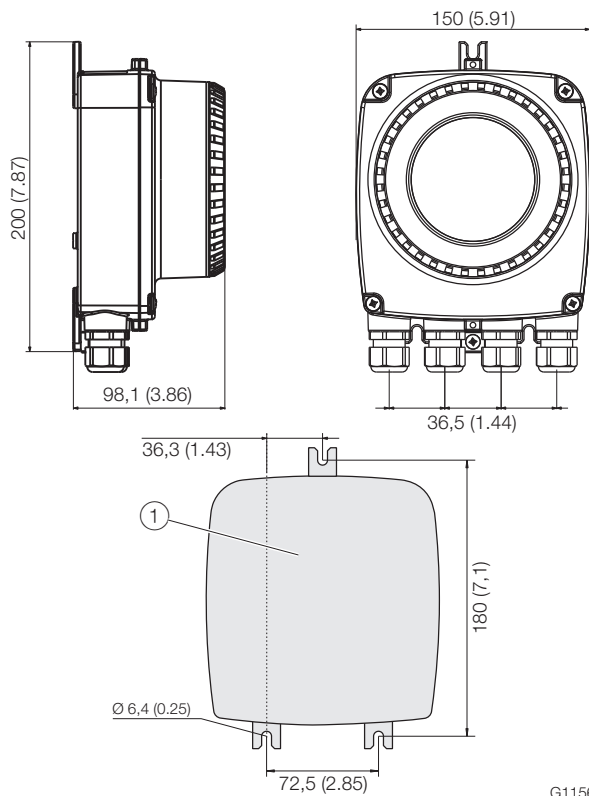

Fig. 23: Mounting dimensions for single-compartment housing

① Hole pattern for mounting holes

5.7 Opening and closing the housing

⚠ WARNING

Risk of injury due to live parts!

When the housing is open, contact protection is not provided and EMC protection is limited.

Before opening the housing, switch off the power supply.

ℹ NOTICE

Adverse effect on IP rating

- Check the O-ring gasket for damage and replace it if necessary before closing the housing cover.
- Check that the O-ring gasket is properly seated when closing the housing cover.

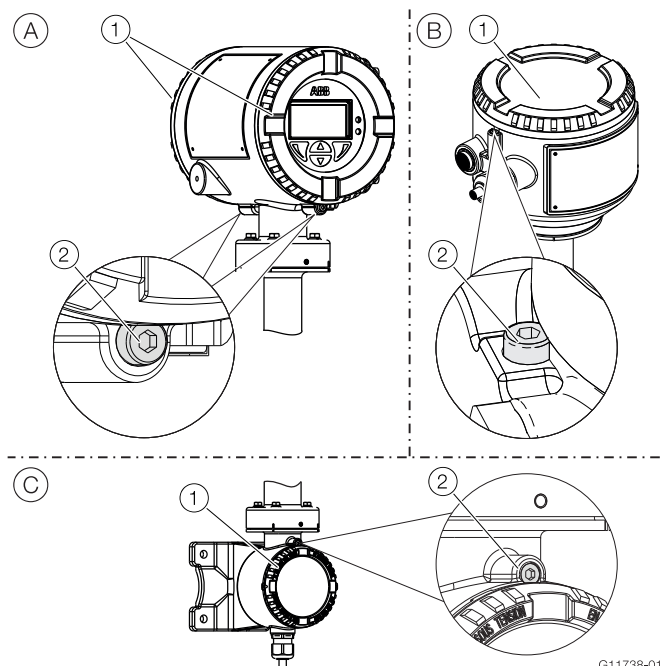

Fig. 24: Cover lock (example)

Ⓐ Integral mount design Ⓑ Remote mount design Ⓒ Transmitter, terminal space, signal cable

Open the housing:

1. Release the cover lock by screwing in the Allen screw ②.
2. Unscrew the transmitter housing cover ①.

Close the housing:

1. Remount the transmitter housing cover ①
2. After closing the housing, lock the housing cover by unscrewing the Allen screw ②.

i NOTICE

Adverse effect on IP rating

- Check the gasket for damage and replace it if necessary before closing the housing cover.
- Check that the gasket is properly seated when closing the housing cover.

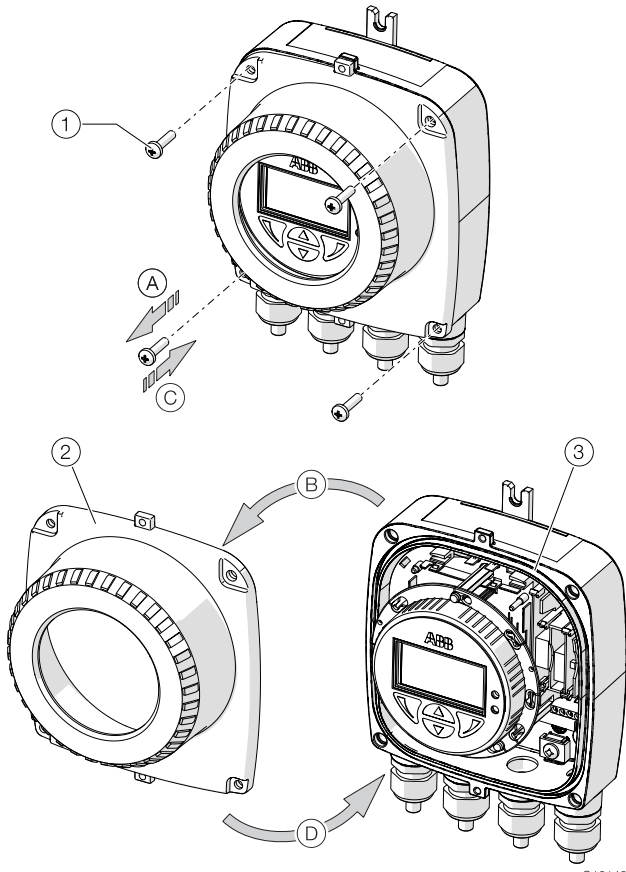

G12149

Fig. 25: Opening / closing single-compartment housing
 ① Screws for housing cover (4x) ② Transmitter housing cover
 ③ Gasket

To open the housing: Perform steps ① and ②.

To close the housing: Perform steps ③ and ④.

5.7.1 Rotating the transmitter housing and LCD display

Depending on the installation position, the transmitter housing or LCD display can be rotated to enable horizontal readings.

Transmitter enclosure

⚠ DANGER

Damaging the device carries a risk of explosion!

Never disconnect the transmitter housing from the sensor.
 Only loosen the screws shown when rotating the transmitter housing!

Rotating the transmitter housing: Perform steps ① ... ③.

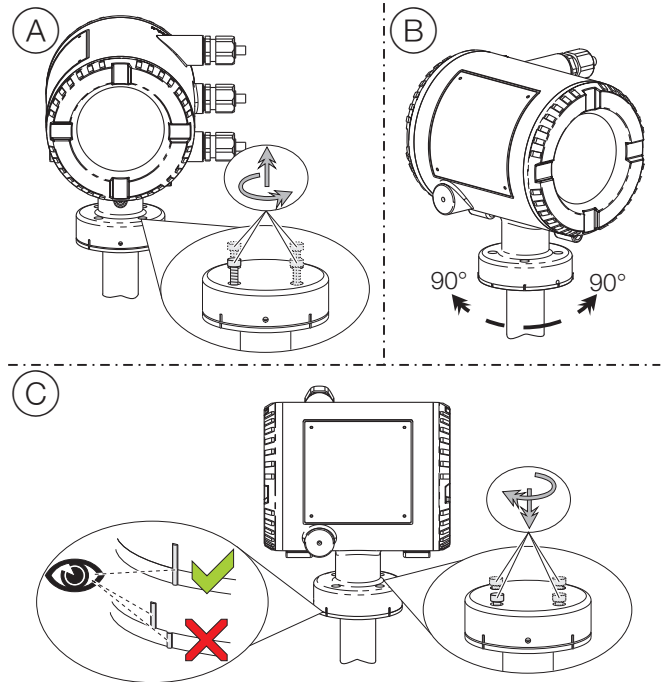

G11569

Fig. 26: Rotating the transmitter housing

LCD indicator - dual-compartment housing

The LCD indicator can be rotated in 3 increments of 90°. Refer to chapter 'Opening and closing the housing' on page 25! Rotating the LCD indicator: Perform steps (A) ... (F).

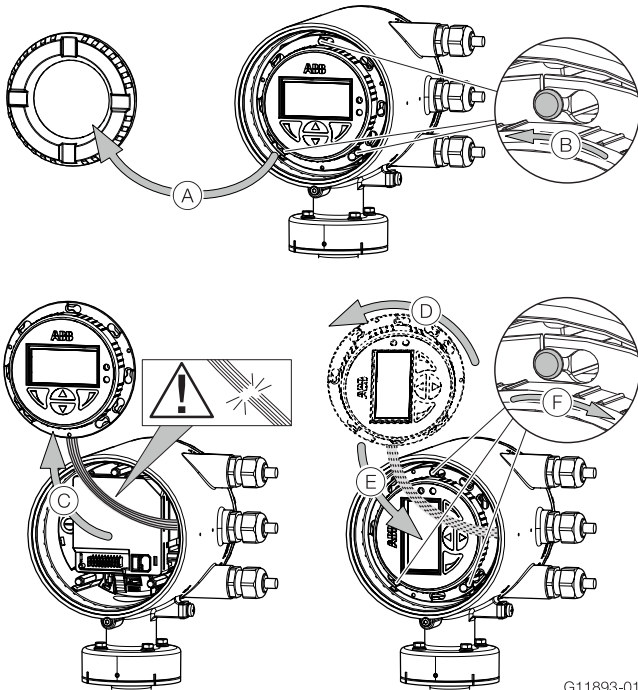

Fig. 27: Rotating the LCD indicator

G11893-01

LCD indicator - single-compartment housing

The LCD indicator can be rotated in 3 increments of 90°. Refer to chapter 'Opening and closing the housing' on page 25! Rotating the LCD indicator: Perform steps (A) ... (F).

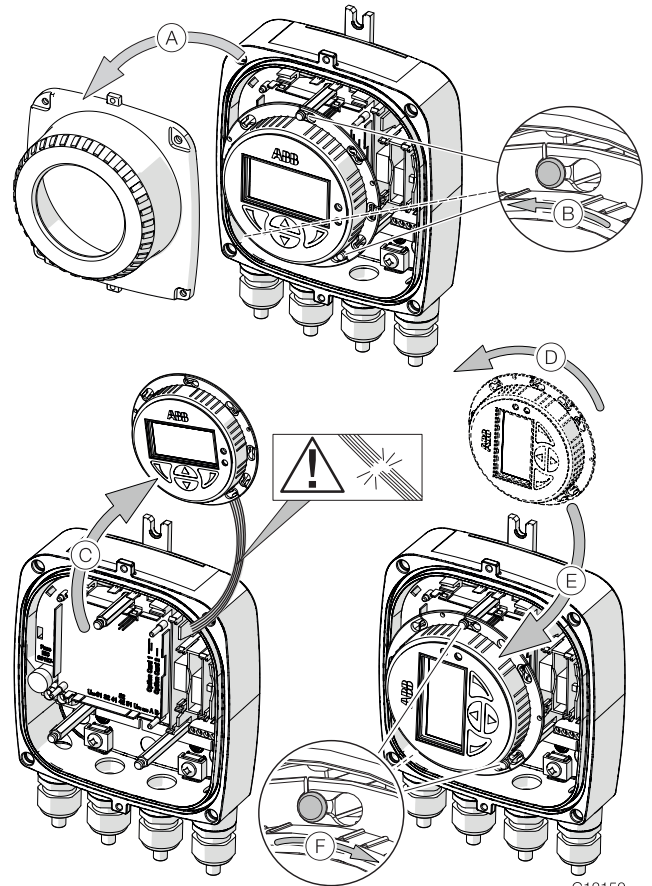

Fig. 28: Rotating the LCD indicator

G12150

5.8 Installing the plug-in cards

⚠ WARNING

Loss of Ex-approval!

Loss of Ex approval due to retrofitting of plug-in cards on devices for use in potentially explosive atmospheres.

- Devices for use in potentially explosive atmospheres must not be retrofitted with plug-in cards.
- If devices are to be used in potentially explosive atmospheres, the required plug-in cards must be specified when the order is placed.

Optional plug-in cards

The transmitter has two slots (OC1, OC2) in which plug-in cards can be inserted to provide additional inputs and outputs. The slots are located on the transmitter motherboard and can be accessed after removing the front housing cover.

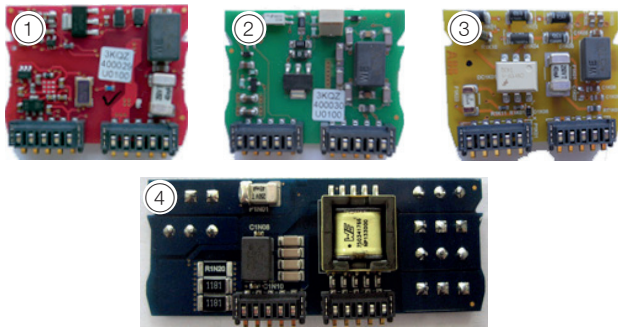
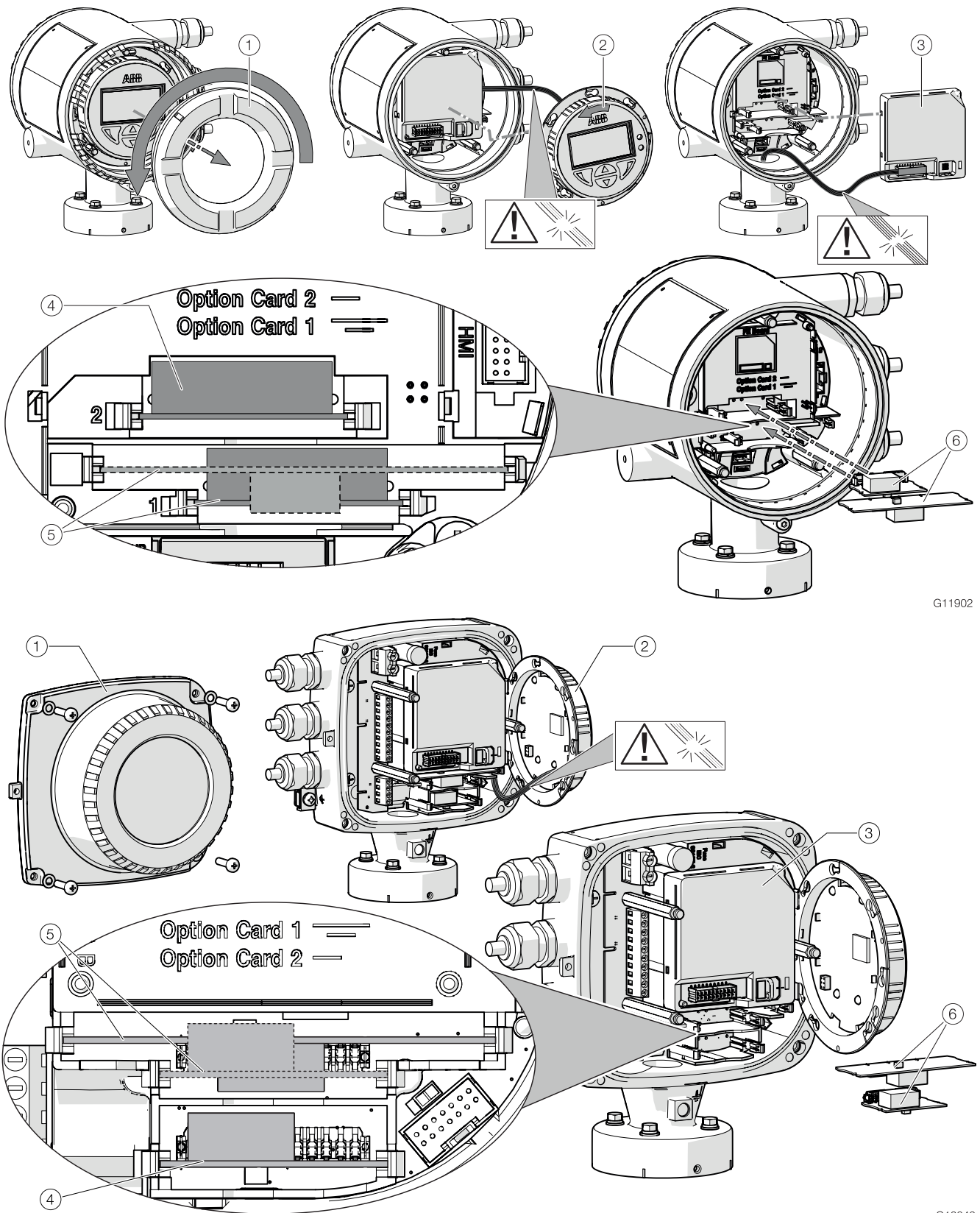

Fig. 29: plug-in cards

Plug-in card	Number ¹⁾
① Passive current output, 4 ... 20 mA (red) Order no. 3KQZ400029U0100	2
② Passive digital output (green) Order no. 3KQZ400030U0100	1
③ Passive digital input (yellow) 3KQZ400032U0100	2
④ 24 V DC power supply (blue) 3KQZ400031U0100	1

1) The "Number" column indicates the maximum number of plug-in cards of the same type that can be used.



G11902

G12349

Fig. 30: Installation of plug-in cards (example, dual-compartment and single-compartment housing)

- ① Cover ② LCD display ③ Frontend board (FEB, only in integral mount design) ④ Socket OC2 ⑤ Socket OC1 ⑥ Plug-in cards

⚠ WARNING**Risk of injury due to live parts!**

When the housing is open, contact protection is not provided and EMC protection is limited.

Before opening the housing, switch off the power supply.

i NOTICE**Damage to components!**

The electronic components of the printed circuit board can be damaged by static electricity (observe ESD guidelines).

Make sure that the static electricity in your body is discharged before touching electronic components.

1. Switch off the power supply.
2. Unscrew / remove the cover.
3. Remove the LCD indicator. Ensure that the cable harness is not damaged.
Insert the LCD display into the bracket (only for single-compartment housings)
4. Remove frontend board (only in integral mount design and dual-compartment housing). Ensure that the cable harness is not damaged.
5. Insert the plug-in card in the corresponding slot and engage. Ensure that the contacts are aligned correctly.
6. Attach the frontend board, insert the LCD display and screw on / replace the cover.
7. Connect outputs V1 / V2 and V3 / V4 in accordance with chapter 'Electrical connections' on page 30.
8. After powering up the power supply, configure the plug-in card functions.

5.9 Electrical connections**⚠ WARNING****Risk of injury due to live parts.**

Improper work on the electrical connections can result in electric shock.

- Connect the device only with the power supply switched off.
- Observe the applicable standards and regulations for the electrical connection.

The electrical connection may only be established by authorized specialist personnel and in accordance with the connection diagrams.

The electrical connection information in this manual must be observed; otherwise, the IP rating may be adversely affected. Ground the measurement system according to requirements.

5.9.1 Connecting the power supply**i NOTICE**

- Observe the power supply limit values in accordance with the information on the name plate.
- Observe the voltage drop for large cable lengths and small conductor cross-sections. The voltage at the terminals of the device may not fall below the minimum value required in accordance with the information on the name plate.

The power supply is connected to terminal L (phase), N (neutral), or 1+, 2-, and PE, as stated on the name plate. A circuit breaker with a maximum rated current of 16 A must be installed in the power supply line of the transmitter. The wire cross-sectional area of the power supply cable and the circuit breaker used must comply with VDE 0100 and must be dimensioned in accordance with the current consumption of the flowmeter measuring system. The cables must comply with IEC 227 and/or IEC 245.

The circuit breaker should be located near the transmitter and marked as being associated with the device.

Connect the transmitter and sensor to functional earth.

5.9.2 Cable entries

The electrical connection is made via cable entries with a 1/2" NPT or M20 x 1.5 thread.

Devices with an M20 x 1.5 or 1/2" NPT thread are supplied with protective plugs.

The black protective plugs in the cable glands are intended to provide protection during transport.

Any unused cable entries must be sealed before commissioning using sealing plugs in accordance with the applicable local standards.

- Observe the maximum torque of 4.5 Nm (3.3 ft lb) when tightening the M20 cable gland.
- Make sure that the outer dimension of cable used, fits the clamping range of the cable gland.

5.9.3 Installing the connecting cables

Ensure that a drip loop (water trap) is used when installing the connecting cables for the sensor.

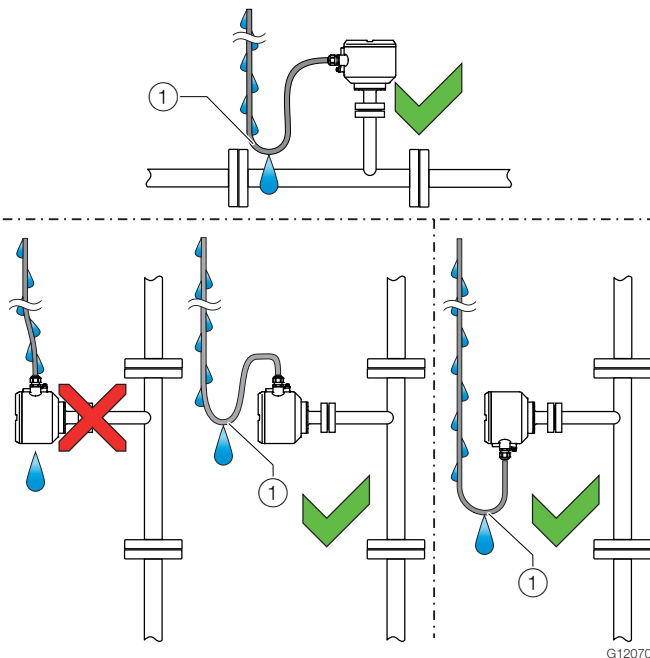

Fig. 31: Laying of the connecting cable

① Drip loop

5.9.4 Signal cable

The signal cable used for the connection of the transmitter and sensor must fulfill at least the following technical specifications.

Cable specification	
Impedance	100 ... 200 Ω
Withstand voltage	120 V
Outer diameter	6 ... 12 mm (0.24 ... 0.47 inch)
Cable design	Two wire pairs as a star-quad cable
Conductor cross-section	Length-dependent
Shield	Copper braid with approximately 85 % coverage
Temperature range	Depends on application.

Maximum signal cable length

0.25 mm ² (AWG 24)	50 m (164 ft)
0.34 mm ² (AWG 22)	100 m (328 ft)
0.5 mm ² (AWG 20)	150 m (492 ft)
0.75 mm ² (AWG 19)	200 m (656 ft)

Recommended cables

It is recommended to use an ABB signal cable with the order number 3KQZ407123U0100 for standard applications.

The ABB signal cable fulfills the above-mentioned cable specification and can be utilized unrestrictedly up to an ambient temperature of $T_{amb.} = 80\text{ }^{\circ}\text{C}$ (176 $^{\circ}\text{F}$).

5.9.5 Electrical connection (HART protocol)

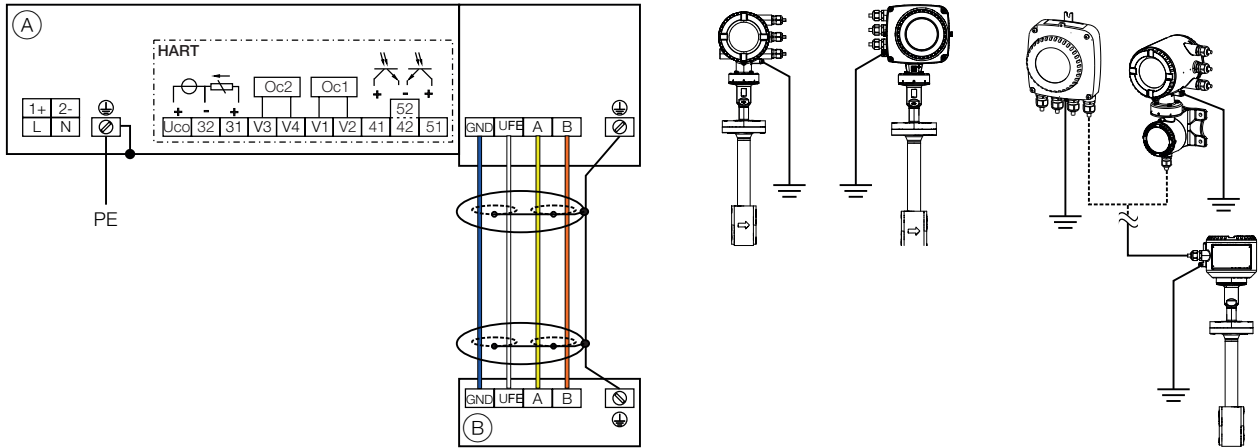

Fig. 32: (A) transmitter (B) sensor

Connections for the power supply

AC voltage	
Terminal	Function / comments
L	Phase
N	Neutral conductor
PE / ⊕	Protective earth (PE)
	Potential equalization
DC voltage	
Terminal	Function / comments
1+	+
2-	-
PE / ⊕	Protective earth (PE)
	Potential equalization

Connections for inputs and outputs

Terminal	Function / comments
Uco / 32	Active 4 ... 20 mA current output / HART or
31 / 32	Passive 4 ... 20 mA current output / HART
41 / 42	Passive digital output DO1
51 / 52	Passive digital output DO2
V1 / V2	Plug-in card, slot Oc1
V3 / V4	Plug-in card, slot Oc2
For details, see chapter 'Optional plug-in cards' on page 28.	

Connecting the signal cable

Only for remote mount design.

The sensor housing and transmitter housing must be connected to potential equalization.

Terminal	Function / comments
U _{FE}	Sensor power supply
GND	Ground
A	Data line
B	Data line
	Functional earth / Shielding

5.10 Electrical data for inputs and outputs

Power supply

AC voltage	
Terminals	L / N
Operating voltage	100 ... 240 V AC, (-15 % / +10 %), 47 ... 64 Hz
Power consumption	S_{max} : < 20 VA
Power-up current	18.4 A, $t < 3$ ms

DC voltage	
Terminals	1+ / 2-
Operating voltage	24 V DC \pm 20 %
Ripple	< 5 %
Power Consumption	P_{max} : < 20 W
Power-up current	21 A, $t < 10$ ms

HART communication

A HART DTM in accordance with FDT1.2 standards is available. HART protocol based Integrations in other Tools or systems (e.g., Emerson AMS/Siemens PCS7) are available on request. The DTM, the DD and EDD is available for download from www.abb.com/flow.

HART output	
Terminals	Active: Uco / 32 Passive: 31 / 32
Protocol	HART 7.1
Transmission	FSK modulation on current output 4 ... 20 mA in accordance with Bell 202 standard
Baud rate	1200 baud
Signal amplitude	Maximum 1.2 mAss
Current output load	Minimum 250 Ω
Cable	0,25 mm ² (AWG 24), twisted
Maximum cable length	1200 m (3937 ft)

NOTICE

The HART protocol is not secure, as such the intended application should be assessed to ensure that these protocols are suitable before implementation.

Current output Uco / 32, 31 / 32

Can be configured for the output of mass flow and volume flow.

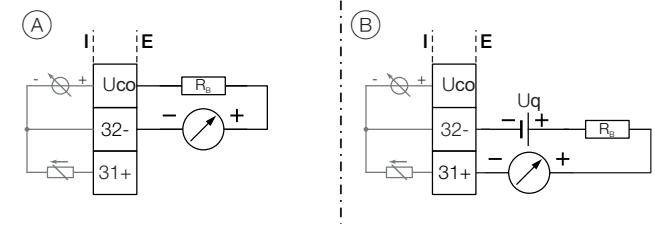
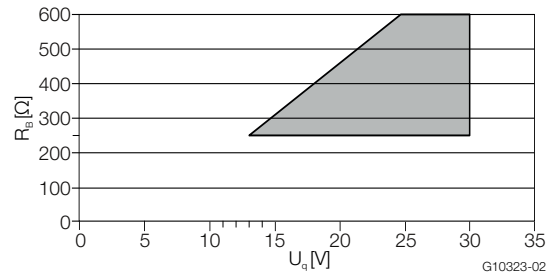

Fig. 33: (I = Internal, E = External, R_B = load, U_q = Source voltage)

(A) Current output Uco / 32 (B) , active current output 31 / 32, passive



Permissible source voltage U_q for passive outputs in relation to load resistance where $I_{max} = 22$ mA. ■■■ = Permissible range

Fig. 34: Source voltage for passive outputs

Current output	Active	Passive
Terminals	Uco / 32	31 / 32
Output signal	4 ... 20 mA	4 ... 20 mA
Load R_B	$250 \Omega \leq R_B \leq 300 \Omega$	$250 \Omega \leq R_B \leq 600 \Omega$
Source voltage U_q ¹⁾	—	$13 V \leq U_q \leq 30 V$
Measuring error	< 0.1 % of measured value	
Insulation	The current output and digital outputs are electrically isolated.	

1) Source voltage U_q depends on the load R_B and must be within the permissible range.

Digital output 41 / 42, 51 / 52

These can be configured as pulse outputs, frequency outputs or binary outputs.

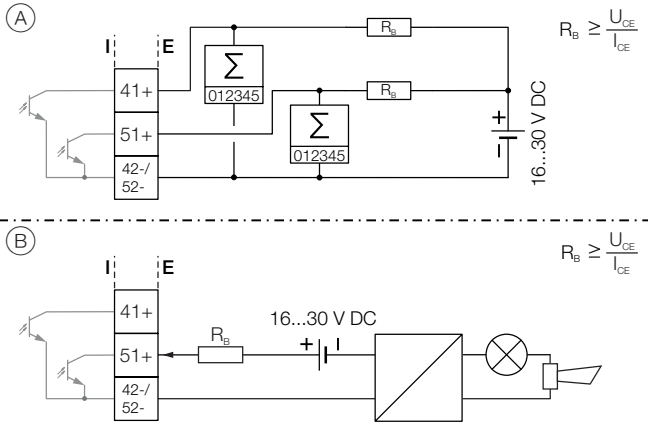

Fig. 35: (I = internal, E = external, R_B = load)

- (A) Passive digital output 41 / 42, 51 / 52 as pulse or frequency output
- (B) Passive digital output 51 / 52 as binary output

Pulse / frequency output (passive)	
Terminals	41 / 42, 51 / 52
Output "closed"	$0\text{ V} \leq U_{CEL} \leq 3\text{ V}$ For $f < 2.5\text{ kHz}$: $2\text{ mA} < I_{CEL} < 10\text{ mA}$ For $f > 2.5\text{ kHz}$: $10\text{ mA} < I_{CEL} < 30\text{ mA}$
Output "open"	$16\text{ V} \leq U_{CEH} \leq 30\text{ V DC}$ $0\text{ mA} \leq I_{CEH} \leq 0.2\text{ mA}$
f_{max}	10 kHz
Pulse width	0.05 ... 2000 ms

Binary output (passive)	
Terminals	41 / 42, 51 / 52
Output "closed"	$0\text{ V} \leq U_{CEL} \leq 3\text{ V}$ $2\text{ mA} \leq I_{CEL} \leq 30\text{ mA}$
Output "open"	$16\text{ V} \leq U_{CEH} \leq 30\text{ V DC}$ $0\text{ mA} \leq I_{CEH} \leq 0.2\text{ mA}$
Switching function	Configurable See chapter 'Menu: Input/Output ' on page 81.

NOTICE

- Terminals 42 / 52 have common grounding. Digital outputs 41 / 42 and 51 / 52 are not electrically isolated from each other. An electrically isolated digital output can be made using a plug-in module.
- If you are using a mechanical counter, we recommend setting a pulse width of $\geq 30\text{ ms}$ and a maximum frequency of $f_{max} \leq 3\text{ kHz}$.

Current output V1 / V2, V3 / V4 (plug-in card)

Up to two additional current outputs can be implemented via the "Passive current output (red)" plug-in card.

The plug-in card can be used in slot OC1 or in OC2.

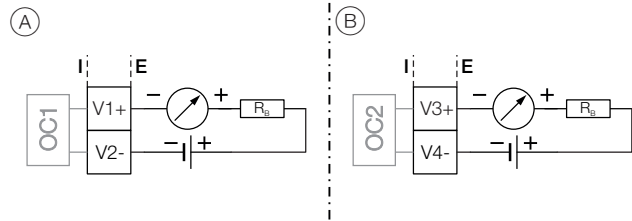
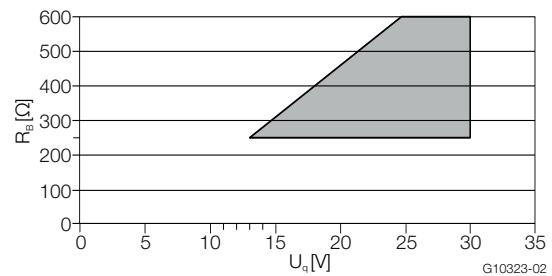

Fig. 36: (I = internal, E = external, R_B = load)

- (A) Passive current output V1 / V2
- (B) Passive current output V3 / V4



Permissible source voltage U_q for passive outputs in relation to load

resistance where $I_{max} = 22\text{ mA}$. ■ = Permissible range

Fig. 37: Source voltage for passive outputs

Passive current output	
Terminals	V1 / V2, V3 / V4
Output signal	4 ... 20 mA
Load R_B	$250\ \Omega \leq R_B \leq 600\ \Omega$
Source voltage	$13\text{ V} \leq U_q \leq 30\text{ V}$
Measuring error	$< 0.1\%$ of measured value

- 1) The source voltage U_q depends on the load R_B and must be within the permissible range.

Digital output V1 / V2, V3 / V4 (plug-in card)

An additional binary output can be implemented via the "Passive digital output (green)" plug-in card.

The plug-in card can be used in slot OC1 or in OC2.

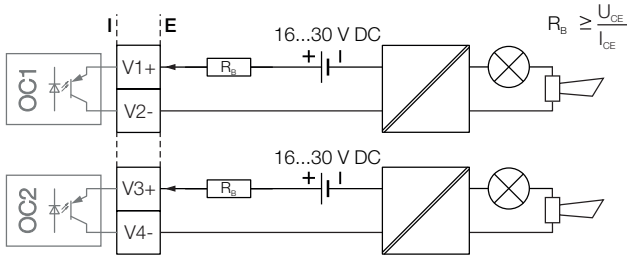

Fig. 38: Plug-in card as binary output (I = internal, E = external, R_b = load)

Binary output (passive)	
Terminals	V1 / V2, V3 / V4
Output "closed"	0 V ≤ U _{CEL} ≤ 3 V 2 mA < I _{CEL} < 30 mA
Output "open"	16 V ≤ U _{CEH} ≤ 30 V DC 0 mA ≤ I _{CEH} ≤ 0.2 mA
Switching function	Configurable. See chapter 'Menu: Input/Output' on page 81.

Digital input V1 / V2, V3 / V4 (plug-in module)

Up to two additional digital inputs can be implemented via the "Passive digital input (yellow)" plug-in card.

The plug-in card can be used in slot OC1 and / or OC2.

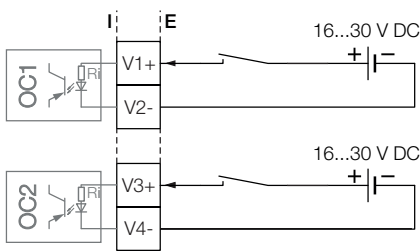

Fig. 39: Plug-in card as digital input (I = internal, E = external)

Digital input	
Terminals	V1 / V2, V3 / V4
Input "On"	16 V ≤ U _{KL} ≤ 30 V
Input "Off"	0 V ≤ U _{KL} ≤ 3 V
Internal resistance	R _i = 6.5 kΩ
Function	Configurable See chapter 'Menu: Input/Output' on page 81.

24 V DC power supply V1 / V2 (plug-in card)

The power supply plug-in card allows a passive output on the transmitter to be used as an active output. See chapter 'Connection examples' on page 36.

The plug-in card can only be used in slot OC1.

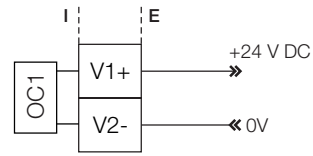

Fig. 40: (I = Internal, E = External)

24 V DC power supply	
Terminals	V1 / V2
Function	For active connection of passive outputs
Output voltage	24 V DC at 0 mA, 17 V DC at 25 mA
Load rating I _{max}	25 mA, permanently short circuit-proof

NOTICE

When using the device in potentially explosive atmospheres, the power supply plug-in card must only be used to power one passive output. It must not be connected to multiple passive outputs!

5.10.1 Connection examples

Input and output functions are configured via the device software in accordance with the desired application. See chapter 'Parameter descriptions' on page 65.

Active digital output 41 / 42, 51 / 52, V3 / V4

When the "24 V DC power supply (blue)" plug-in card is used, the digital outputs on the basic device and on the plug-in cards can also be wired as active digital outputs.

NOTICE

Each "power supply (blue)" plug-in card must only power one output. It must not be connected to two outputs (e.g. digital output 41 / 42 and 51 / 52)!

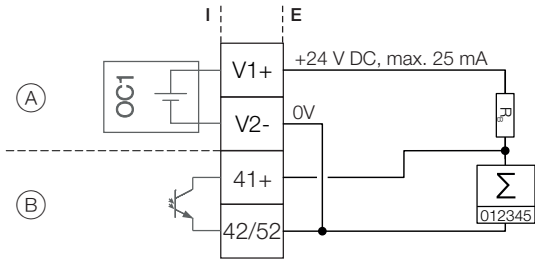

Fig. 41: Active digital output 41 / 42 (example)
 (A) Plug-in card "Power supply (blue)" in slot 1
 (B) Digital output 41 / 42

The connection example shows usage for digital output 41 / 42; the same applies to usage for digital output 51 / 52.

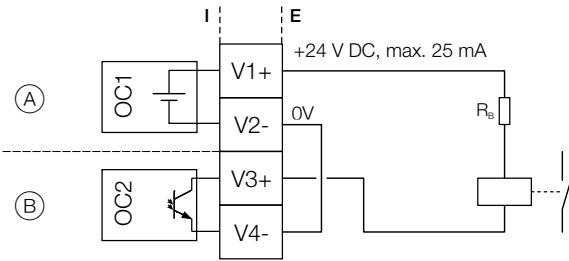

Fig. 42: Active digital output V3 / V4 (example)
 (A) Plug-in card "Power supply (blue)" in slot 1
 (B) Plug-in card "Digital output (green)" in slot 2

Active current output V3 / V4

When the "24 V DC power supply (blue)" plug-in card is used, the current output on the plug-in card can also be wired as the active current output.

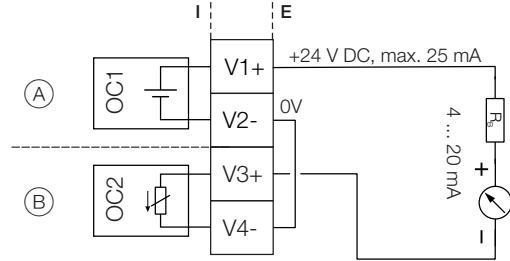

Fig. 43: Active current output V3 / V4 (example)
 (A) Plug-in card "Power supply (blue)" in slot 1
 (B) Plug-in card "Passive current output (red)" in slot 2

Active digital input V3 / V4

When the "24 V DC power supply (blue)" plug-in card is used, the digital input on the plug-in card can also be wired as the active digital input.

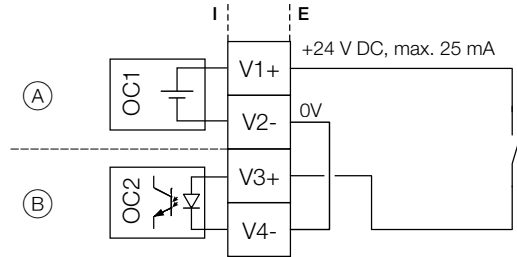

Fig. 44: Active digital input V3 / V4 (example)
 (A) Plug-in card "Power supply (blue)" in slot 1
 (B) Plug-in card "Passive digital input (yellow)" in slot 2

G11914

G11913

5.10.2 Connection to integral mount design

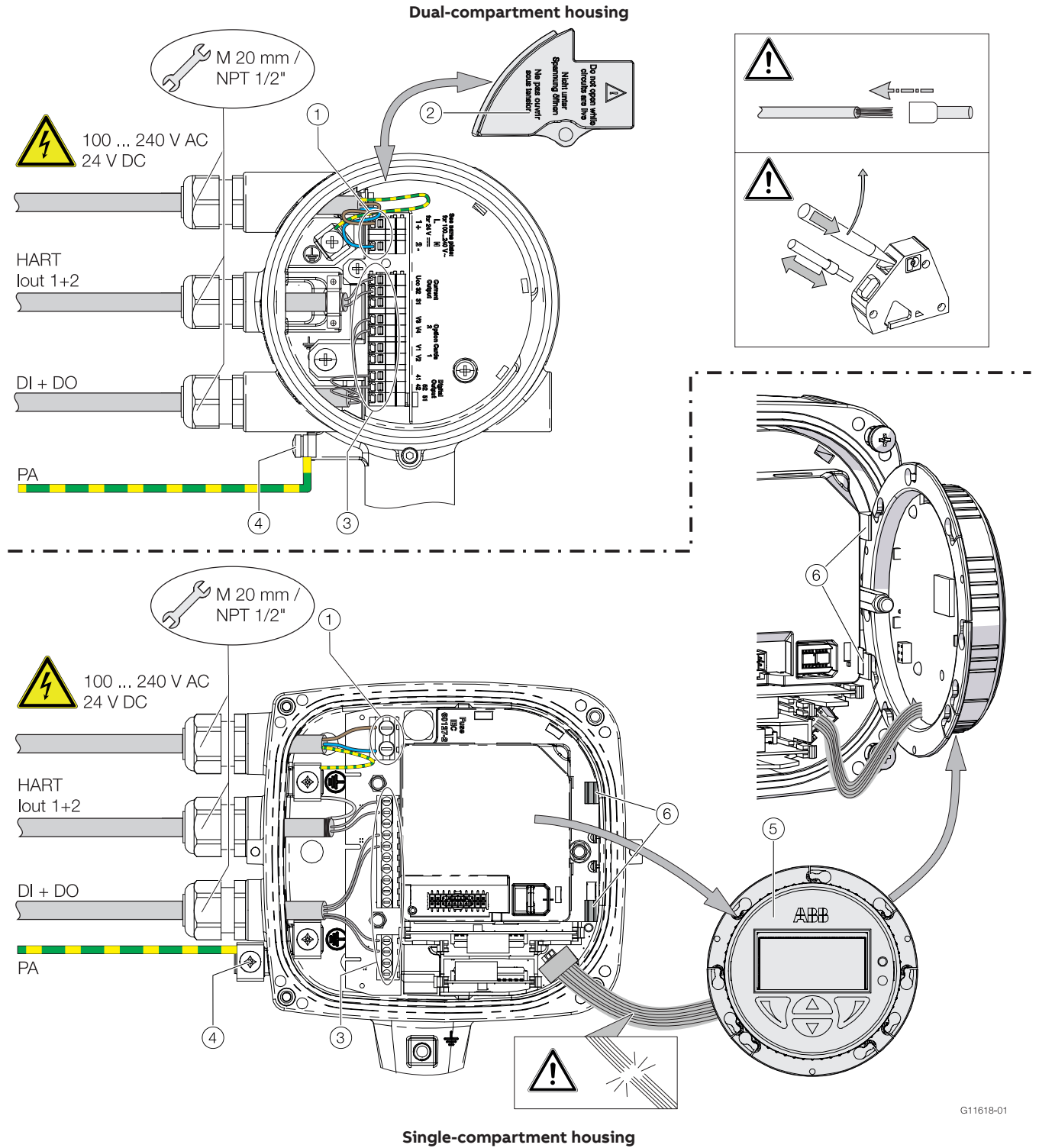

Fig. 45: Connection to integral mount design (example)

- ① Terminals for power supply
- ② Cover for power supply terminals
- ③ Terminals for inputs and outputs
- ④ Terminal for potential equalization
- ⑤ LCD display
- ⑥ Holder for LCD display (parking position)

i NOTICE

If the O-ring gasket is seated incorrectly or damaged, this may have an adverse effect on the housing protection class.

Follow the instructions in chapter 'Opening and closing the housing' on page 25 to open and close the housing safely.

Observe the following points when connecting to an electrical supply:

- Lead the power supply cable into the housing through the top cable entry.
- Lead the cables for signal inputs and signal outputs into the housing through the middle and, where necessary, bottom cable entries.
- Connect the cables in accordance with the electrical connection diagram. If present, connect the cable shielding to the earthing clamp provided.
- Use wire end ferrules when connecting.
- After connecting the power supply to the dual-compartment housing, terminal cover ② must be installed.
- Close unused cable entries using suitable plugs.

**5.10.3 Connection to remote mount design
Transmitter**

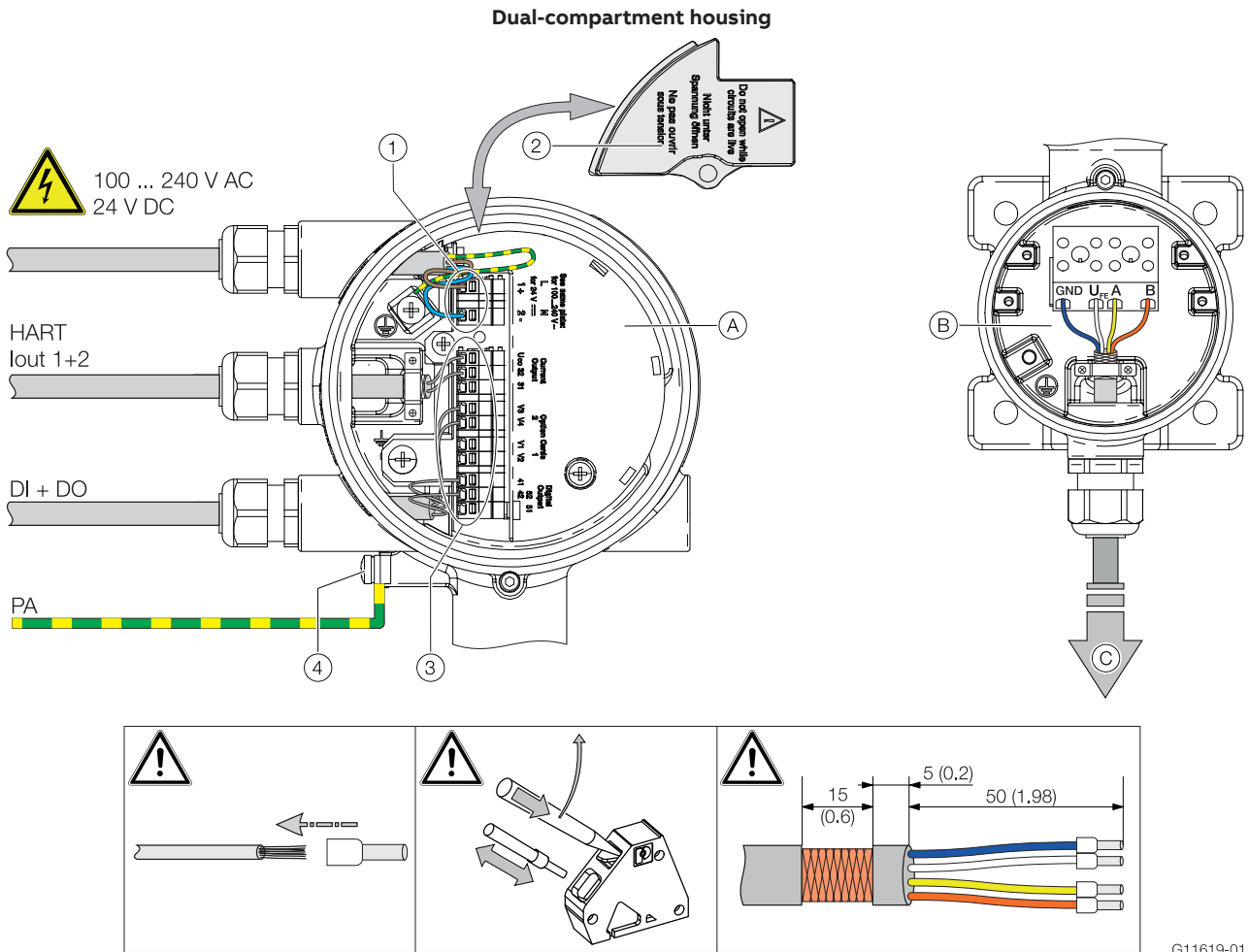

G11619-01

Fig. 46: Connection to transmitter in remote mount design (example, dimensions in mm (inch))

- (A) Upper terminal compartment (backside)
- (B) Lower terminal compartment
- (C) Signal cable to flowmeter sensor
- (1) Terminals for power supply
- (2) Cover for power supply terminals
- (3) Terminal for signal cable
- (4) Terminals for inputs and outputs
- (5) Terminal for potential equalization

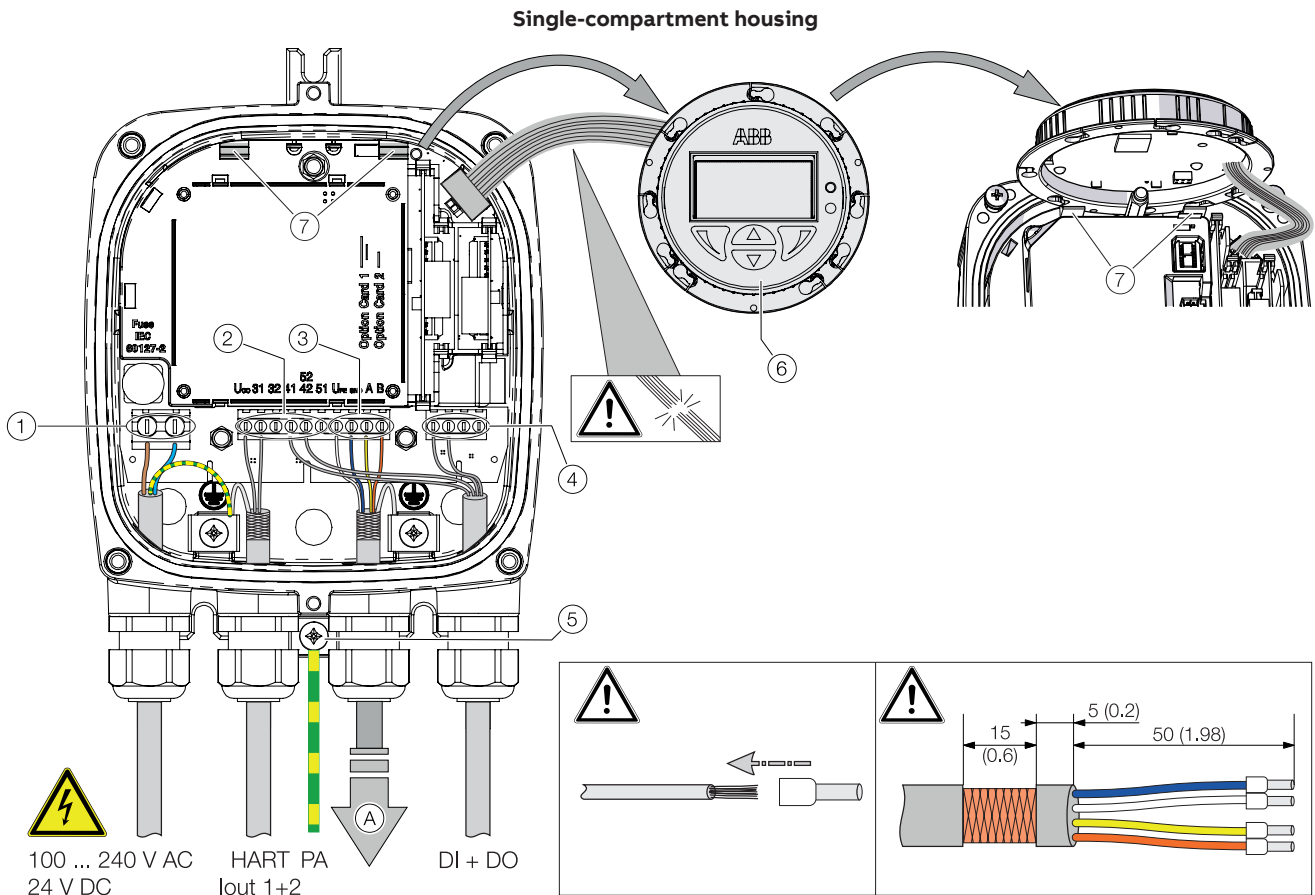

G12155

Fig. 47: Connection to transmitter in remote mount design (example, dimensions in mm (inch))

- (A) Signal cable to flowmeter sensor
- (1) Terminals for power supply (2) Terminals for inputs and outputs (basic device) (3) Terminal for signal cable (4) Terminals for inputs and outputs (plug-in modules) (5) Terminal for potential equalization (6) LCD display (7) Holder for LCD display (parking position)

i NOTICE

If the O-ring gasket is seated incorrectly or damaged, this may have an adverse effect on the housing protection class. Follow the instructions in chapter 'Opening and closing the housing' on page 25 to open and close the housing safely.

Observe the following points when connecting to an electrical supply:

- Lead the cable for the power supply and the signal inputs and outputs into the housing as shown.
- The signal cable to the sensor is connected in the lower connection area of the transmitter.
- Connect the cables in accordance with the electrical connection diagram. If present, connect the cable shielding to the earthing clamp provided.
- Use wire end ferrules when connecting.
- After connecting the power supply, terminal cover (2) must be installed.
- Close unused cable entries using suitable plugs.

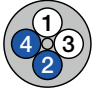
Terminal	ABB signal cable 3KQZ407123U0100	HELKAMA signal cable 20522
	 G11748a	 G11748b
GND	Blue	Blue (4)
U _{FE}	White	White (3)
A	Yellow	Blue (2)
B	Orange	White (1)

Flowmeter sensor

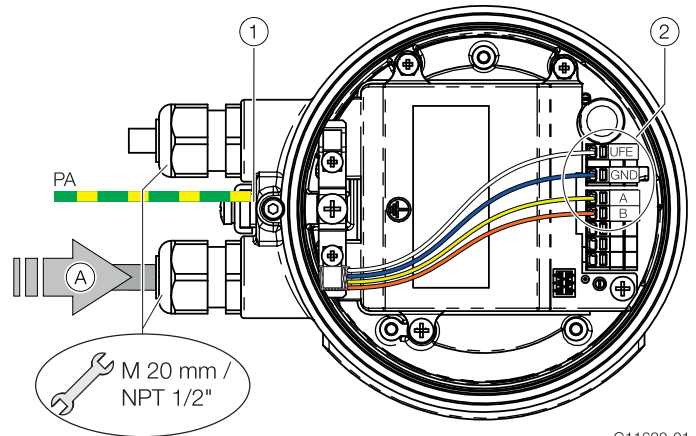
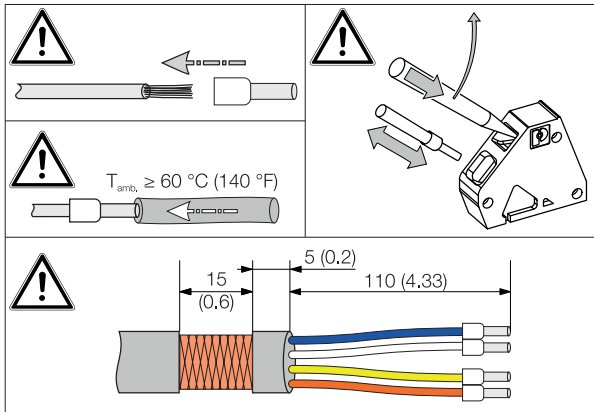

G11620-01



Fig. 48: Connection to sensor in remote mount design (example)

- (A) Signal cable from Transmitter
- (1) Terminal for potential equalization (2) Terminals for signal cable

NOTICE

If the O-ring gasket is seated incorrectly or damaged, this may have an adverse effect on the housing protection class. Follow the instructions in chapter 'Opening and closing the housing' on page 25 to open and close the housing safely.

- Observe the following points when connecting to an electrical supply:
- Lead the signal cable into the housing as shown.
 - Connect the cables in accordance with the electrical connection diagram. If present, connect the cable shielding to the earthing clamp provided.
 - Use wire end ferrules when connecting.
 - At $T_{amb} \geq 60 \text{ °C}$ (140 °F) the cable leads within the connection box of the sensor have to be insulated with supplied silicon tubes.
 - Close unused cable entries using suitable plugs.

Terminal	ABB signal cable 3KQZ407123U0100	HELKAMA signal cable 20522
	 G11748a	 G11748b
GND	Blue	Blue (4)
U _{FE}	White	White (3)
A	Yellow	Blue (2)
B	Orange	White (1)

6 Commissioning

6.1 Safety instructions

CAUTION

Risk of burns due to hot measuring media.

The device surface temperature may exceed 70 °C (158 °F), depending on the measuring medium temperature!

Before starting work on the device, make sure that it has cooled sufficiently.

If there is a chance that safe operation is no longer possible, take the device out of operation and secure it against unintended startup.

6.2 Hardware settings

6.2.1 Dual-compartment housing

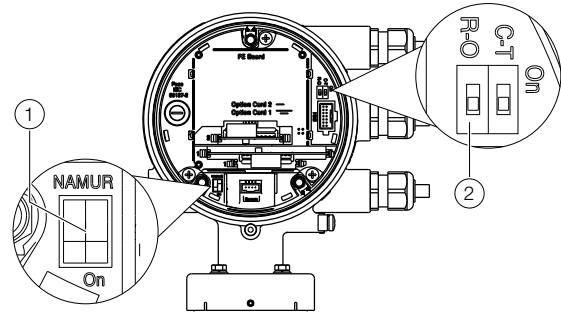

G11779

Fig. 49: Position of DIP switches

① DIP switch, NAMUR ② DIP switch, write protection

DIP switches are located behind the front housing cover. The DIP switches are used to configure specific hardware functions. The power supply to the transmitter must be briefly interrupted in order for the modified setting to take effect.

Write-protect switch

When write protection is activated, device parameterization cannot be changed via the LCD indicator. Activating and sealing the write protection switch protects the device against tampering

NOTICE

The product has an ABB service account that can be disabled with this write protection switch.

Position	Function
On	Write protection active
Off	Write protection deactivated.

Configuration for digital outputs 41 / 42 and 51 / 52

The configuration (NAMUR, optoelectronic coupler) for the digital outputs on the basic device is set via DIP switches in the transmitter.

Position	Function
On	Digital output 41 / 42 and 51 / 52 as NAMUR output.
Off	Digital output 41 / 42 and 51 / 52 as optoelectronic coupler output.

6.2.2 Single-compartment housing

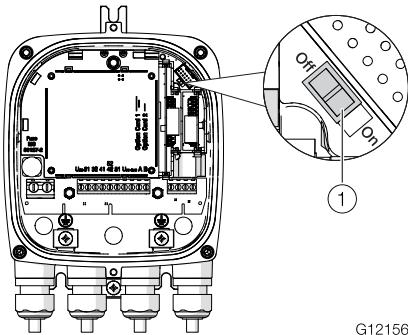

G12156

Fig. 50: Position of DIP switch
 ① DIP switch, write protection

The DIP switch is used to configure specific hardware functions. The power supply to the transmitter must be briefly interrupted or a device reset have to be performed in order for the modified setting to take effect.

Write-protect switch

When write protection is activated, device parameterization cannot be changed via the LCD indicator. Activating and sealing the write protection switch protects the device against tampering.

NOTICE

The product has an ABB service account that can be disabled with this write protection switch.

Position	Function
On	Write protection active
Off	Write protection deactivated.

6.2.3 Configuration for digital outputs V1 / V2 or V3 / V4

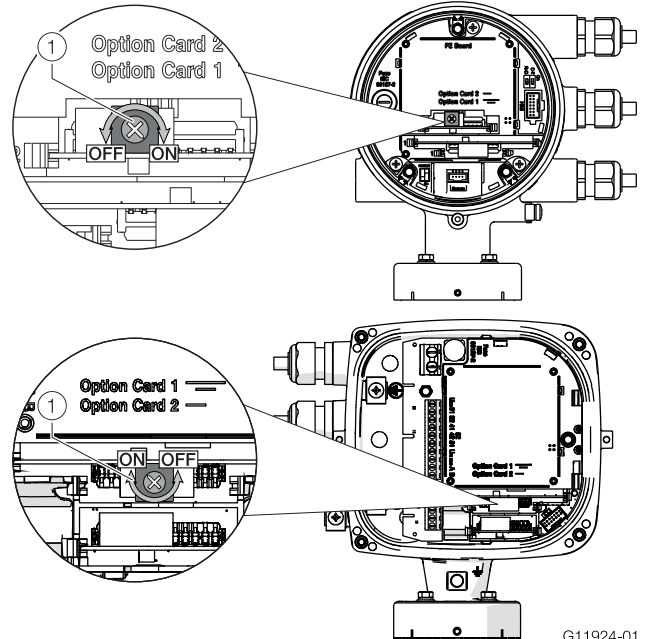

G11924-01

Fig. 51: Position of rotary switch on the plug-in card
 ① NAMUR rotary switch

The configuration (NAMUR, optoelectronic coupler) for the digital output on the plug-in card is set via a rotary switch on the plug-in card.

Position	Function
On	Digital output V1 / V2 or V3 / V4 as NAMUR output.
Off	Digital output V1 / V2 or V3 / V4 as optoelectronic coupler output.

6.3 Checks prior to commissioning

The following points must be checked before commissioning the device:

- The wiring must have been completed as described in the chapter 'Electrical connections' on page 30.
- The correct grounding of the sensor.
- The ambient conditions must meet the requirements set out in the technical data.
- The power supply must meet the requirements set out on the identification plate.

6.4 Parameterization of the device

The SensyMaster FMT430, FMT450 can be commissioned and operated via the integrated LCD indicator (option, see chapter 'Parameterization via the "Easy Setup" menu function' on page 46).

Alternatively, the SensyMaster FMT430, FMT450 can also be commissioned and operated via ABB Asset Vision Basic (FEX61x DTM).

Flowmeter without display operated through a hot pluggable display

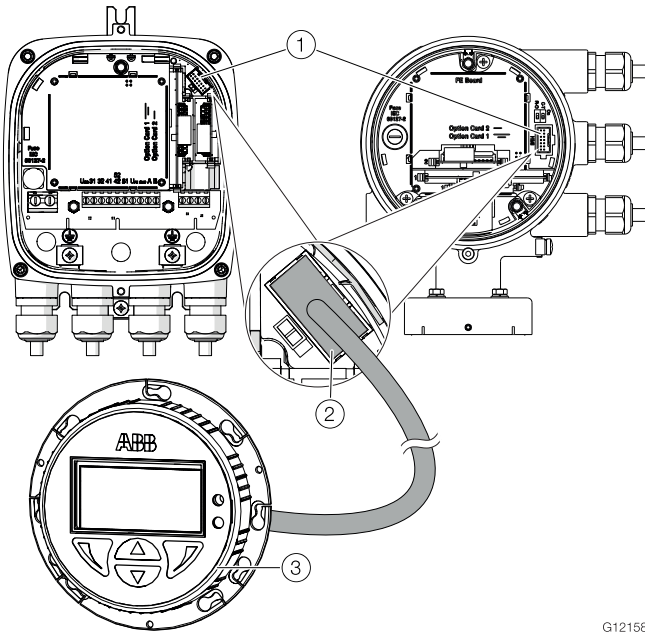

Fig. 52: Optional LCD display

- ① Local operating interface ② Connector plug for LCD display
③ LCD display

The "non display" version of the device can be parameterized using a display which is available as an accessory to the flowmeter.

6.4.1 Parameterization via the local operating interface

⚠ DANGER

Risk of explosion during operation of the device with open terminal box!

Only perform parameterization of the device via the local operating interface outside the potentially explosive area!

A PC / notebook and the USB interface cable are required to configure the device via the device's local operating interface. In conjunction with the HART-DTM and the software "ABB AssetVision" available at www.abb.com/flow, all parameters can also be set without a fieldbus connection.

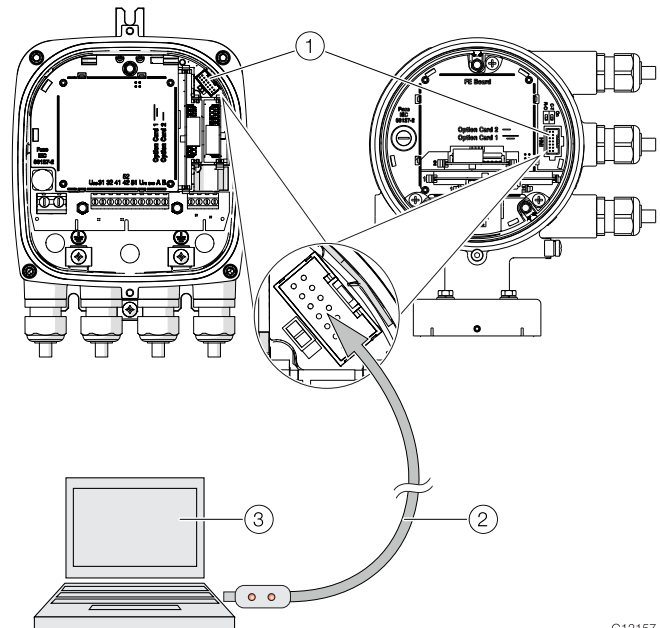

Fig. 53: Connection to the local operating interface

- ① Local operating interface ② USB interface cable ③ PC / notebook

1. Open device terminal box.
2. Connect programming plug to the local operating interface of the device.
3. Insert USB interface cable into a free USB female connector on the PC / notebook.
4. Switch on the device power supply.
5. Start ABB AssetVision and perform the parameterization of the equipment.

Detailed information on operating the software is available in the relevant operating instructions and the DTM online help.

6.4.2 Parameterization via the infrared service port adapter

Configuration via the infrared service port adapter on the device requires a PC / notebook and the FZA100 infrared service port adapter.

All parameters can also be set without a HART connection, using the HART DTM available at www.abb.com/flow and the "ABB AssetVision" software.

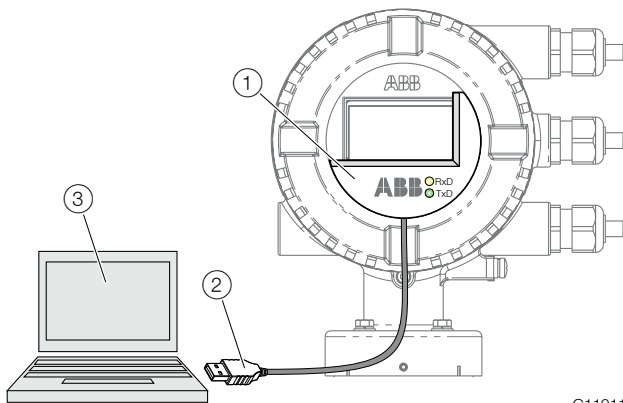

G11911

Fig. 54: Infrared service port adapter on transmitter (example)

- ① Infrared service port adapter ② USB interface cable
③ PC / notebook running ABB AssetVision and HART DTM

1. Position the infrared service port adapter on the front plate of the transmitter as shown
2. Insert USB interface cable into a free USB female connector on the PC / notebook.
3. Switch on the device power supply.
4. Start ABB AssetVision and perform the parameterization of the equipment.

Detailed information on operating the software is available in the relevant operating instructions and the DTM online help.

6.4.3 Parameterization via HART

Configuration via the HART interface on the device requires a PC / notebook and a suitable HART modem. All parameters can also be set via the HART protocol, using the HART DTM available at www.abb.com/flow and the "ABB AssetVision" software.

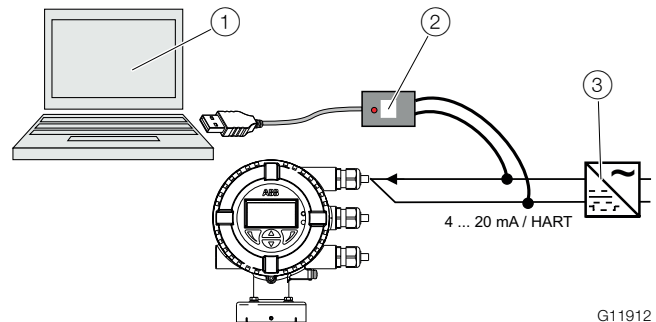

G11912

Fig. 55: HART modem on transmitter (example)

- ① PC / notebook running ABB AssetVision and HART DTM
② HART modem ③ Power supply unit

For more detailed information on operating the software and the HART modem, please refer to the relevant operating instructions and the DTM online help.

6.5 Switching on the power supply

— Switch on the power supply.

The LCD display shows the following display during the startup process:

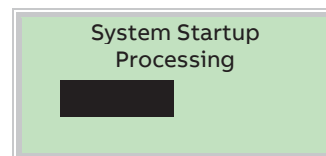



The process display is displayed after the startup process.

6.6 Parameterization via the "Easy Setup" menu function



Settings for the most common parameters are summarized in the "Easy Setup" menu. This menu provides the fastest way to configure the device.

The following section describes parameterization via the "Easy Setup" menu function.

Qm	0.00	kg/h
Qm	0.00	%
Tm	20.00	°C
		

1. Switch to the configuration level with .

Access Level	
Read Only	
Standard	
Back	Select



2. Use  /  to select "Standard".
3. Confirm the selection with .

Enter Password	

RSTUVWXYZ 12345	
Next	OK





4. Use  to confirm the password. A password is not available as factory default; you can continue without entering a password.

Menu	
Easy Setup	
	
Exit	Select

5. Use  /  to select "Easy Setup".
6. Confirm the selection with .





Selection of the menu language.

Easy Setup Language	
Language	
Next	Edit

7. Use  to call up the edit mode.
8. Use  /  to select the desired language.
9. Confirm the selection with .

Configuration of the current output

Easy Setup Curr.Out 31/32/Uco	
Mass Flow [%]	
Next	Edit





10. Use  to call up the edit mode.
11. Using  / , select the desired process value for current output 31 / 32 / Uco.
12. Confirm the selection with .

Easy Setup Curr.Out V1/V2	
Mass Flow [%]	
Next	Edit

Only if an appropriate plug-in card is present!

Easy Setup Curr.Out V3/V4	
Mass Flow [%]	
Next	Edit

Only if an appropriate plug-in card is present!

13. Use  to call up the edit mode.
14. Use  / , select the desired process value for current output V1 / V2 or V3 / V4.
15. Confirm the selection with .

Configuration of the digital outputs

i NOTICE

The devices are supplied standard with deactivated digital outputs. The parameters for configuration of the digital outputs are displayed only if the desired output configuration has been provided upon order or it has been activated in the menu "Input/Output".

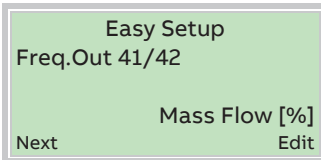

Only available if "Dig.Out 41/42 Mode" Frequency has been selected.

16. Use to call up the edit mode.
17. Using / , select the desired process value for frequency output 41 / 42.
18. Confirm the selection with .

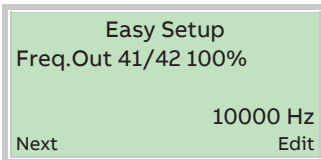

Only available if "Dig.Out 41/42 Mode" Frequency has been selected.

19. Use to call up the edit mode.
20. Using / set the frequency for 100 % of the process variable.
21. Confirm the selection with .

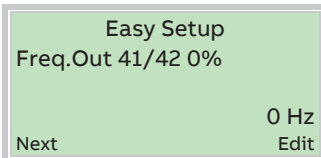

Only available if "Dig.Out 41/42 Mode" Frequency has been selected.

22. Use to call up the edit mode.
23. Using / set the frequency for 0 % of the process variable.
24. Confirm the selection with .

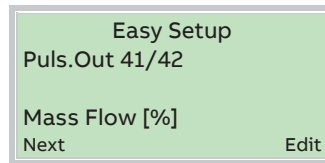

Only available if "Dig.Out 41/42 Mode" Pulse has been selected.

25. Use to call up the edit mode.
26. Using / , select the desired process value for pulse output 41 / 42.
27. Confirm the selection with .



Only available if "Dig.Out 41/42 Mode" Pulse has been selected.

28. Use to call up the edit mode.
29. Use / to select the desired pulse width for the pulse output..
30. Confirm the selection with .

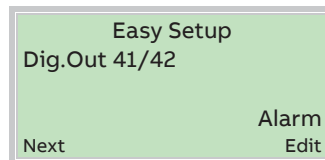

Only available if "Dig.Out 41/42 Mode" Binary has been selected.

31. Use to call up the edit mode.
32. Using / , select the desired function for binary output 41 / 42.
33. Confirm the selection with .

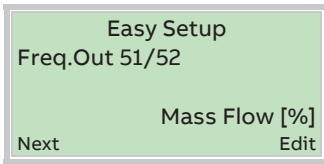

Only available if "Dig.Out 51/52 Mode" Frequency has been selected.

34. Use to call up the edit mode.
35. Using / , select the desired process value for frequency output 51 / 52.
36. Confirm the selection with .

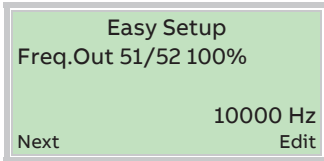

Only available if "Dig.Out 51/52 Mode" Frequency has been selected.

37. Use to call up the edit mode.
38. Using / set the frequency for 100 % of the process variable.
39. Confirm the selection with .

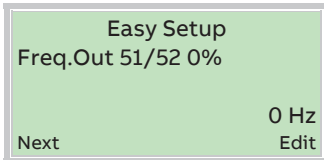

Only available if "Dig.Out 51/52 Mode" Frequency has been selected.

40. Use to call up the edit mode.
41. Using / set the frequency for 0 % of the process variable.
42. Confirm the selection with .

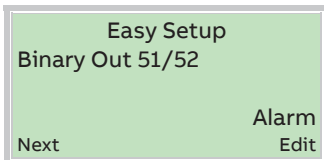

Only available if "Dig.Out 51/52 Mode" Binary has been selected.

43. Use to call up the edit mode.
44. Using / , select the desired function for binary output 51 / 52.
45. Confirm the selection with .

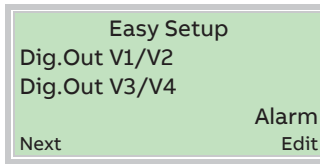

Only if for Dig.Out V1/V2 Mode or Dig.Out V3/V4 Mode Binary has been selected and an appropriate plug-in card is present!

46. Use to call up the edit mode.
47. Use / to select the desired function for binary output V1 / V2 or V3 / V4.
48. Confirm the selection with .

Fixed selection of the application

Only if the selection is not being made via the digital inputs.

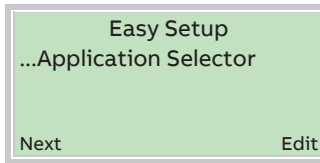

49. Use to call up the edit mode.
50. Use / to select the desired application.
51. Confirm the selection with .

Select the application using the digital inputs

Only if the appropriate plug-in cards are present and the application switching function (“Act. App.Selector1|3” or “Act. App.Selector2|3”) has been selected.

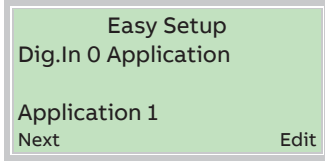

The application is selected if both digital inputs are inactive.

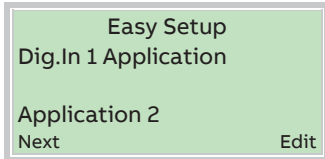

The application is selected if digital input 1 is active.

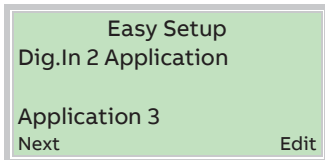

The application is selected if digital input 2 is active.

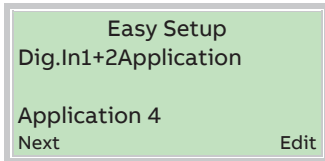

The application is selected if both digital inputs are active.

- 52. Use to call up the edit mode.
- 53. Use / to assign the applications to the respective digital inputs.
- 54. Confirm the selection with .

Select measuring ranges and units



Only if Mass Flow [unit] or Mass Flow [%] have been selected as process value for a current, frequency or pulse output.

- 55. Use to call up the edit mode.
- 56. Use / to select the unit for mass flow measurement.
- 57. Confirm the selection with .

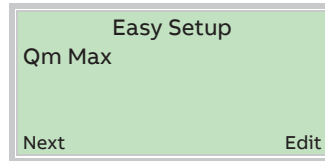

Only if Mass Flow [unit] or Mass Flow [%] have been selected as process value for a current, frequency or pulse output.

- 58. Use to call up the edit mode.
- 59. Use / to set the desired measuring range for mass flow measurement.
- 60. Confirm the selection with .

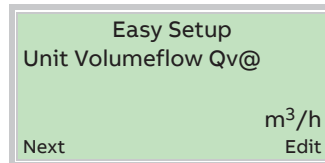



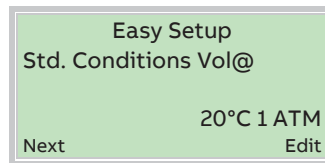

Only if Qv@ [Unit] or Qv@ [%] have been selected as process value for a current, frequency or pulse output.

- 61. Use to call up the edit mode.
- 62. Use / to select the desired unit for volume flow measurement.
- 63. Confirm the selection with .





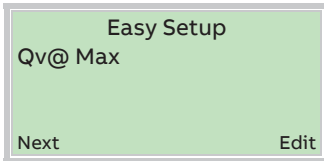

Only if Qv@ [Unit] or Qv@ [%] have been selected as process value for a current, frequency or pulse output.

64. Use  to call up the edit mode.
 65. Use  /  to select the desired standard state for volume flow measurement.
 66. Confirm the selection with .





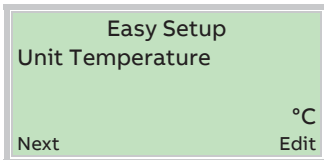

Only if Qv@ [Unit] or Qv@ [%] have been selected as process value for a current, frequency or pulse output.

67. Use  to call up the edit mode.
 68. Use  /  to set the desired measuring range for volume flow measurement.
 69. Confirm the selection with .



Only if Temperature [%] has been selected as process value for a current or frequency output.



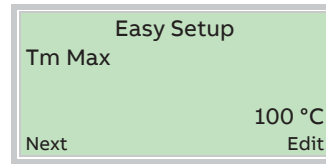

70. Use  to call up the edit mode.
 71. Use  /  to select the desired temperature unit.
 72. Confirm the selection with .

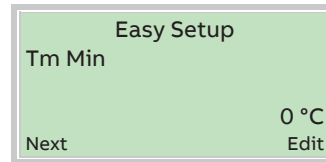





Only if Temperature [%] has been selected as process value for a current or frequency output.

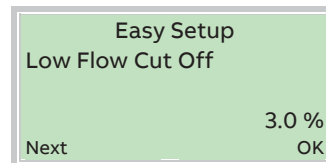

Only if Temperature [%] has been selected as process value for a current or frequency output.

73. Use  to call up the edit mode.
 74. Use  /  to set the desired measuring range for temperature measurement.
 75. Confirm the selection with .



76. Use  to call up the edit mode.
 77. Use  /  to set the desired low flow (% of Q_{mMax} / Q_{VMax}).
 78. Confirm the selection with .

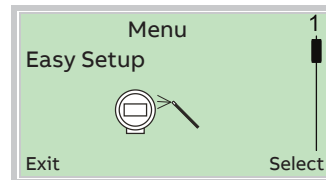

Once all parameter have been set, the main menu appears again. The most important parameters are now set.

79. Use  to switch to the process display.

7 Operation

7.1 Safety instructions

⚠ CAUTION

Risk of burns due to hot measuring media.

The device surface temperature may exceed 70 °C (158 °F), depending on the measuring medium temperature!

Before starting work on the device, make sure that it has cooled sufficiently.

When operating the device, please note the following:

- Aggressive or corrosive media may lead to the damage of wetted parts of the sensor. As a result, measuring medium under pressure can leak out.
- Measuring medium under pressure can leak out due to fatigue on the gasket of the sensor connection or the process connection (e.g. flange or pipe fitting).

If there is a chance that safe operation is no longer possible, take the device out of operation and secure it against unintended startup.

7.2 Menu navigation

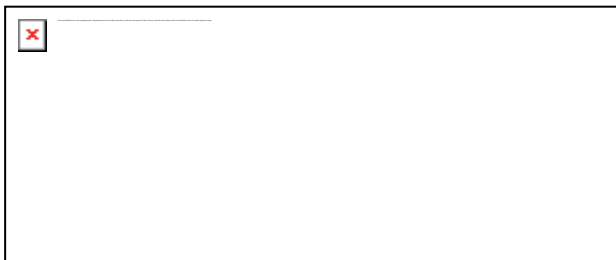





Fig. 56: LCD display



- ① Operating buttons for menu navigation
- ② Menu name display ③ Menu number display
- ④ Marker for indicating relative position within the menu
- ⑤ Display showing the current functions of the  and  operating buttons

The LCD indicator has capacitive operating buttons. These enable you to control the device through the closed housing cover.

ⓘ NOTICE

The transmitter automatically calibrates the capacitive buttons on a regular basis. If the cover is opened during operation, the sensitivity of the buttons is firstly increased to enable operating errors to occur. The button sensitivity will return to normal during the next automatic calibration.

You can use the  or  operating buttons to browse through the menu or select a number or character within a parameter value.

Different functions can be assigned to the  and  operating buttons. The function ⑤ that is currently assigned to them is shown on the LCD display.

Control button functions

	Meaning
Exit	Exit menu
Back	Go back one submenu
Cancel	Cancel a parameter entry
Next	Select the next position for entering numerical and alphanumeric values

	Meaning
Select	Select submenu / parameter
Edit	Edit parameter
OK	Save parameter entered

7.3 Menu levels

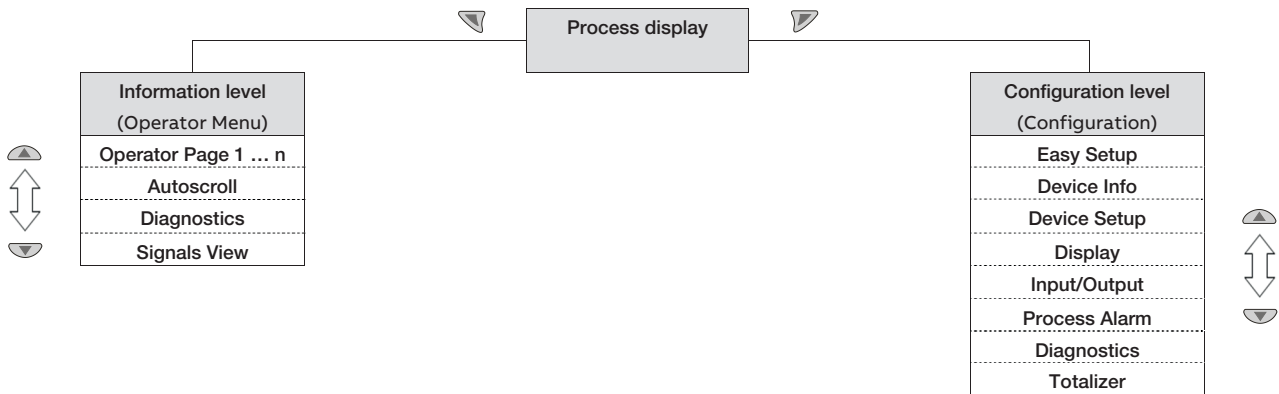

Process display

The process display shows the current process values.
There are two menu levels under the process display.

Information level (Operator Menu)

The information level contains the parameters and information that are relevant for the operator.
The device configuration cannot be changed on this level.

Configuration level (Configuration)

The configuration level contains all the parameters required for device commissioning and configuration. The device configuration can be changed on this level. For detailed information on the parameters, see chapter 'Parameter descriptions' on page 65.

7.3.1 Process display

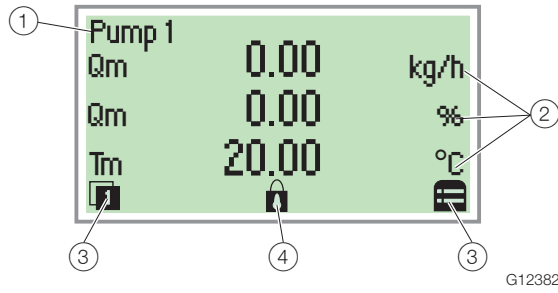

G12382

Fig. 57: Process display (example Display Mode 3x9)

① Measuring point tagging ② Current process values ③ “Switch function” symbol ④ “Parameterization protected” symbol

The process display appears on the LCD display when the device is powered on. It shows information about the device and current process values.

The way in which the current process values are shown can be adjusted on the configuration level.

The symbols at the bottom of the process display are used to indicate the functions of the operating buttons and , in addition to other information.

Symbol	Description
/	Call up information level. When Autoscroll mode is activated, the icon appears here and the operator pages are automatically displayed one after the other.
	Call up configuration level.
	The device is protected against changes in the parametrization.

7.3.2 Switching to the information level (operator menu)

On the information level, the operator menu can be used to display diagnostic information and choose which operator pages to display.

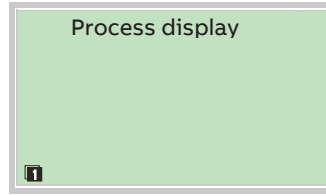

1. Open the Operator Menu using .

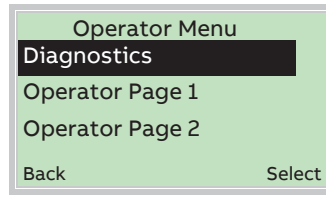

2. Select the desired submenu using / .
3. Confirm the selection with .

Menu	Description
... / Operator Menu	
Diagnostics	Selection of sub-menu "Diagnostics"; see also chapter 'Error messages on the LCD display' on page 54.
Operator Page 1 ... n	Selection of operator page to be displayed.
Autoscroll	When Autoscroll is activated, automatic switching of the operator pages is initiated on the process screen.
Signals View	Selection of submenu "Signals View" (only for service purposes).

7.3.3 Error messages on the LCD display

In the event of an error, a message consisting of a symbol and text (e.g. Electronics) appears at the bottom of the process screen.

The text displayed provides information about the area in which the error has occurred.

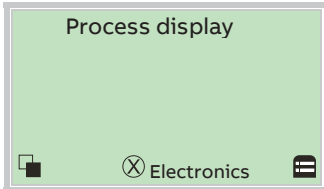

The error messages are divided into four groups in accordance with the NAMUR classification scheme. The group assignment can only be changed using a DTM or EDD:

Symbol	Description
	Error / failure
	Function check
	Outside of the specification
	Maintenance required

The error messages are also divided into the following areas:

Range	Description
Operation	Error / alarm due to the current operating conditions.
Sensor	Error / alarm of the flowmeter sensor.
Electronics	Error / alarm of the electronics.
Configuration	Error / alarm due to device configuration.

i NOTICE

For a detailed description of errors and troubleshooting instructions, please see chapter 'Diagnosis / error messages' on page 93.

7.3.4 Switching to the configuration level (parameterization)

The device parameters can be displayed and changed on the configuration level.

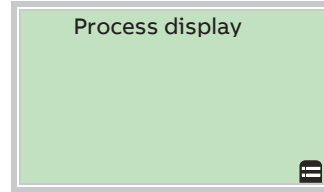

1. Use to switch to the configuration level.

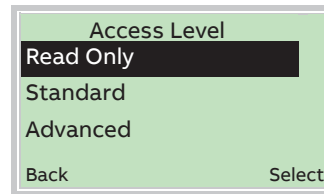

2. Select the desired level of access using / .
3. Confirm the selection with .

i NOTICE

There are three levels of access. A password can be defined for level "Standard".

There is no factory default password.

For security reasons it is recommended, to set a password.

Access Level	Description
Read Only	All parameters are locked. Parameters are read only and cannot be modified.
Standard	All the parameters can be altered. The Customer could configure a password to lock the access to whole device parameters.
Service	The Customer Service has access to the Service menu. In case a Standard password is set than Service level is not accessible with Standard login.

Once you have logged on to the corresponding access level, you can edit or reset the password. Reset (status "no password defined") by selecting "☰" as a password.

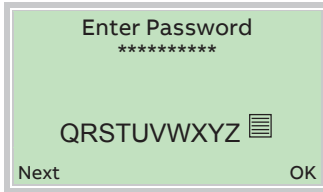

- Enter the corresponding password. No password is preset in the factory settings. Users can switch to the configuration level without entering a password. The selected access level remains active for 3 minutes. Within this time period you can toggle between the process display and the configuration level without re-entering the password.
- Use to confirm the password.

The LCD display now indicates the first menu item on the configuration level.

- Select a menu using / .
- Confirm the selection with .

7.3.5 Selecting and changing parameters

Entry from table

When an entry is made from a table, a value is selected from a list of parameter values.

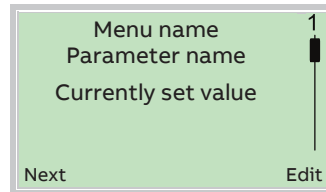

- Select the parameters you want to set in the menu.
- Use to call up the list of available parameter values. The parameter value that is currently set is highlighted.

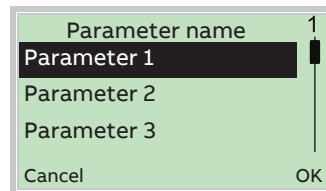

- Select the desired value using / .
- Confirm the selection with .

This concludes the procedure for selecting a parameter value.

Numerical entry

When a numerical entry is made, a value is set by entering the individual decimal positions.

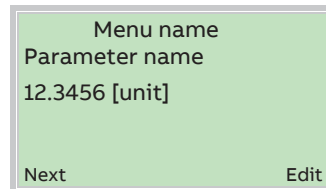

- Select the parameters you want to set in the menu.
- Use to call up the parameter for editing. The decimal place that is currently selected is highlighted.

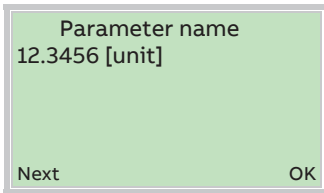

3. Use to select the decimal place to change.
 4. Use / to set the desired value.
 5. Use to select the next decimal place.
 6. If necessary select and set additional decimal places in accordance with steps 3 to 4.
 7. Use to confirm your setting.
- This concludes the procedure for changing a parameter value.

When an alphanumeric entry is made, a value is set by entering the individual decimal positions.

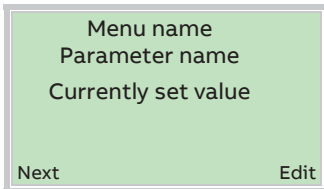

1. Select the parameters you want to set in the menu.
2. Use to call up the parameter for editing. The decimal place that is currently selected is highlighted.

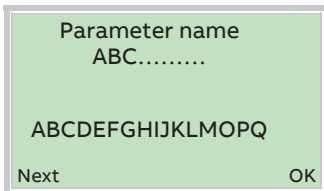

3. Use to select the decimal place to change.
 4. Use / to set the desired value.
 5. Use to select the next decimal place.
 6. If necessary select and set additional decimal places in accordance with steps 3 to 4.
 7. Use to confirm your setting.
- This concludes the procedure for changing a parameter value.

Exiting the setup

For some menu items, values must be entered. If you don't want to change the parameter, you can exit the menu as described below.

1. Pressing (Next) repeatedly moves the cursor to the right. Once the cursor reaches the end position, "Cancel" is displayed in the lower right of the screen.
2. terminates editing and exits the menu item. Use to return to the start.

i NOTICE

The LCD display automatically returns to the process display three minutes after the last button has been actuated.

7.4 Parameter overview

i NOTICE

This overview of parameters shows all the menus and parameters available on the device. Depending on the version and configuration of the device, not all of the menus and parameters may be visible in it.

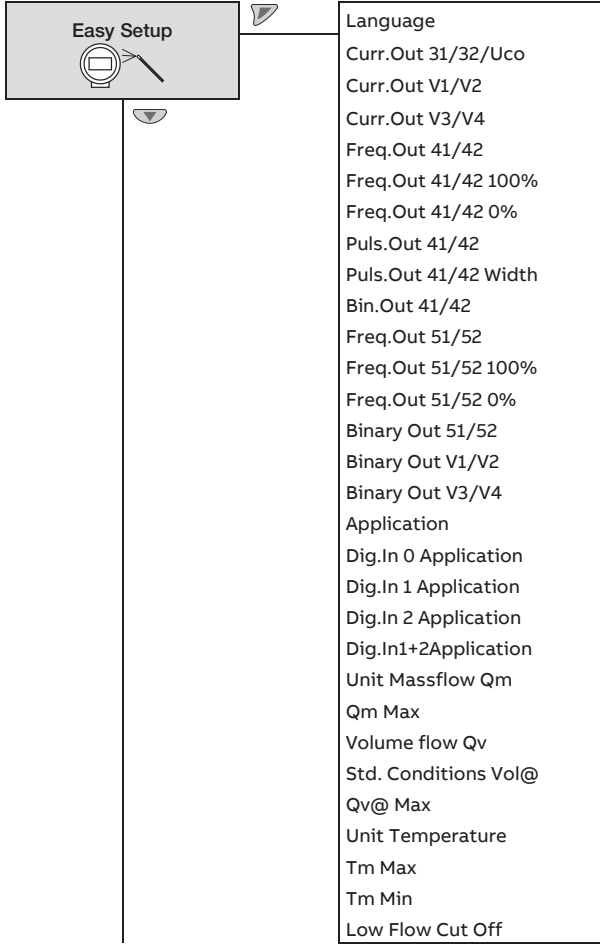

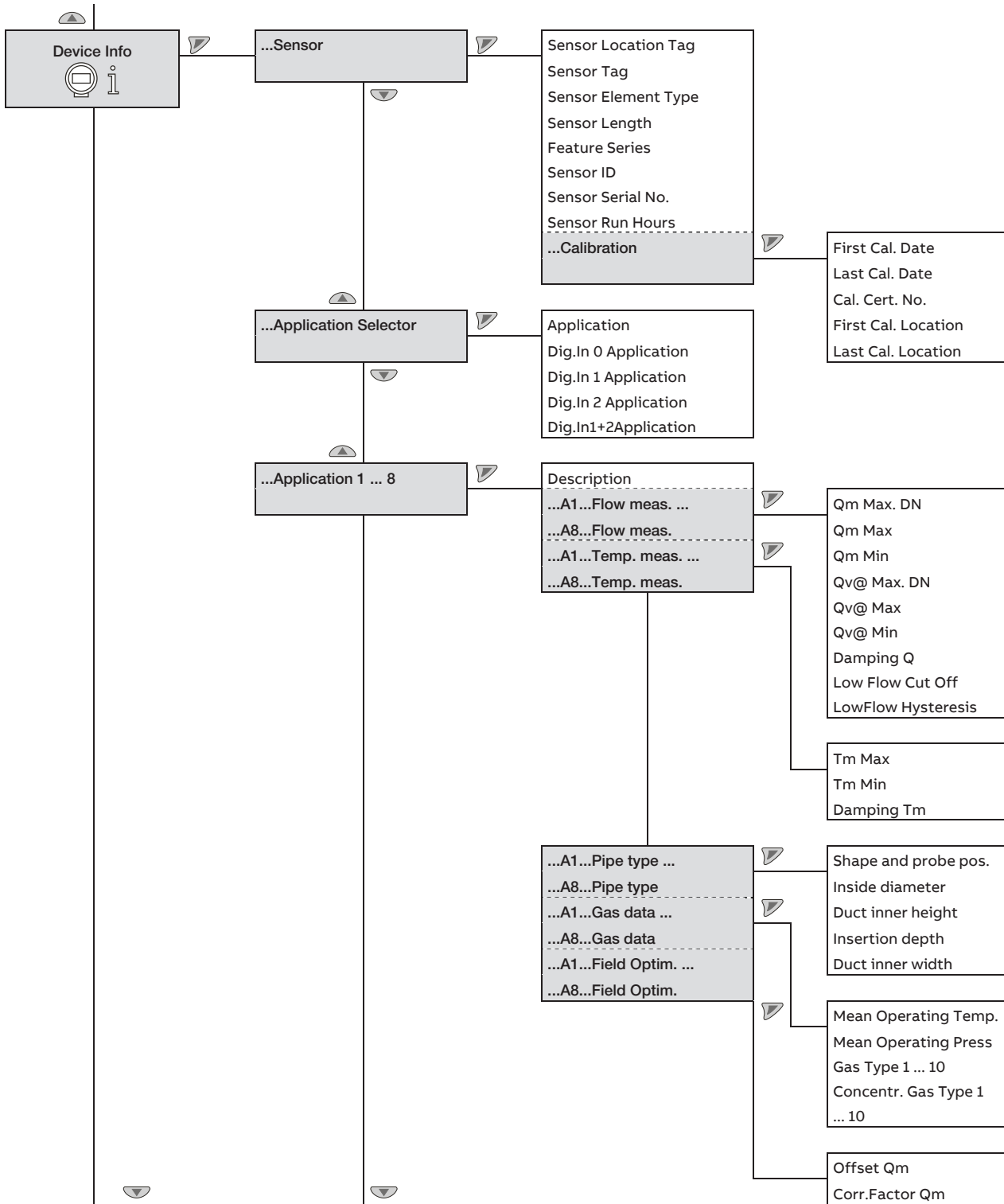

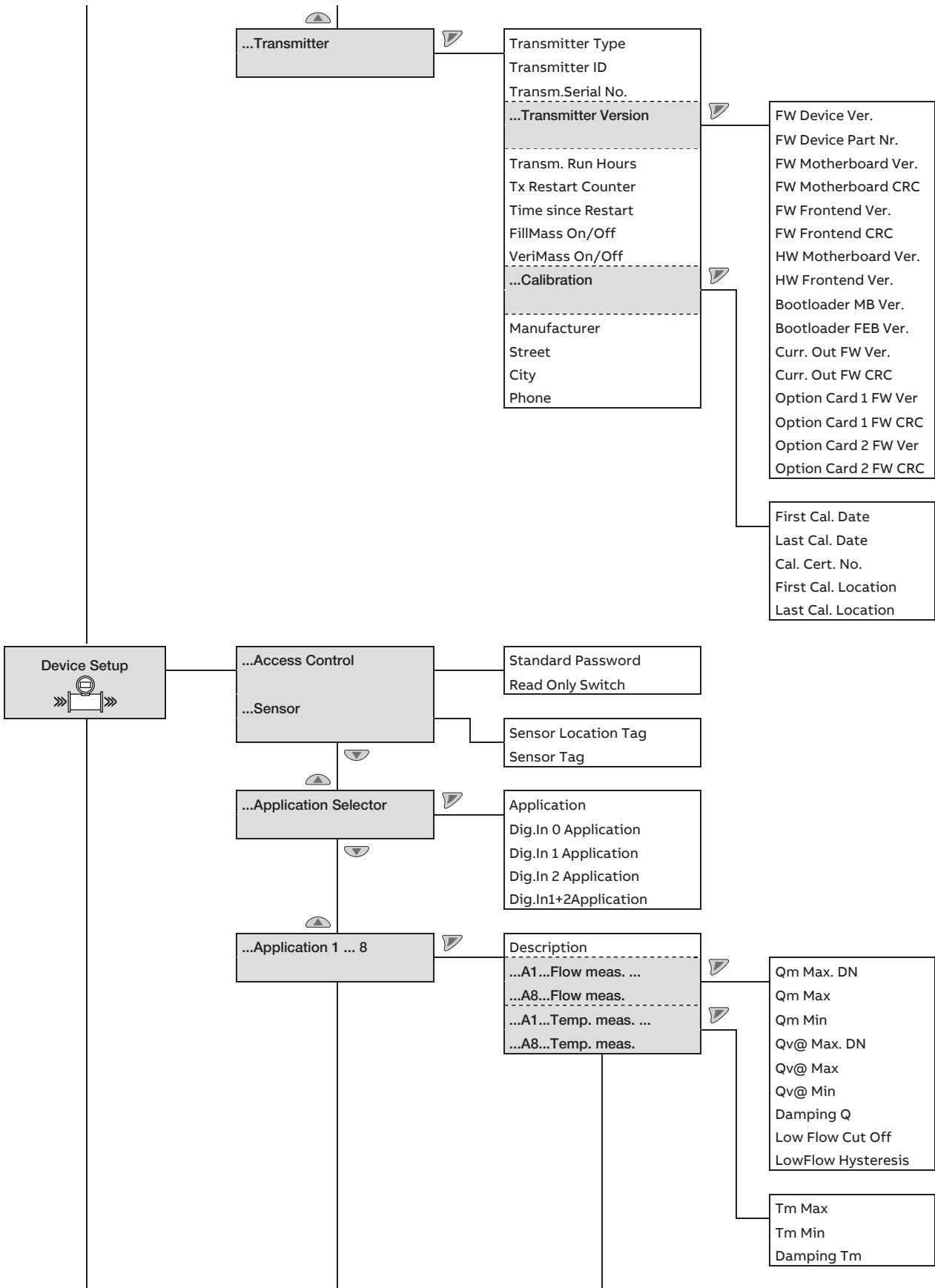

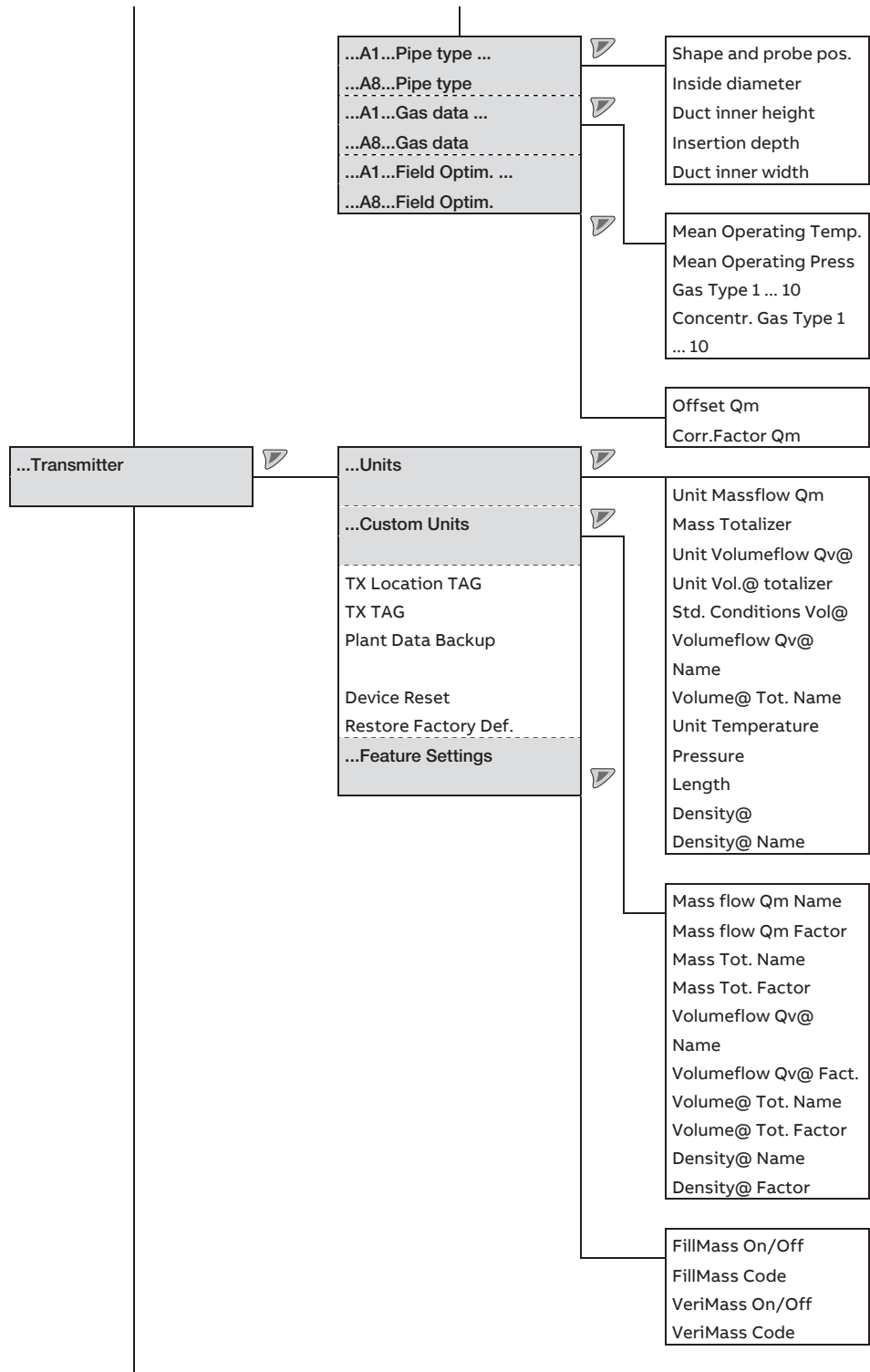

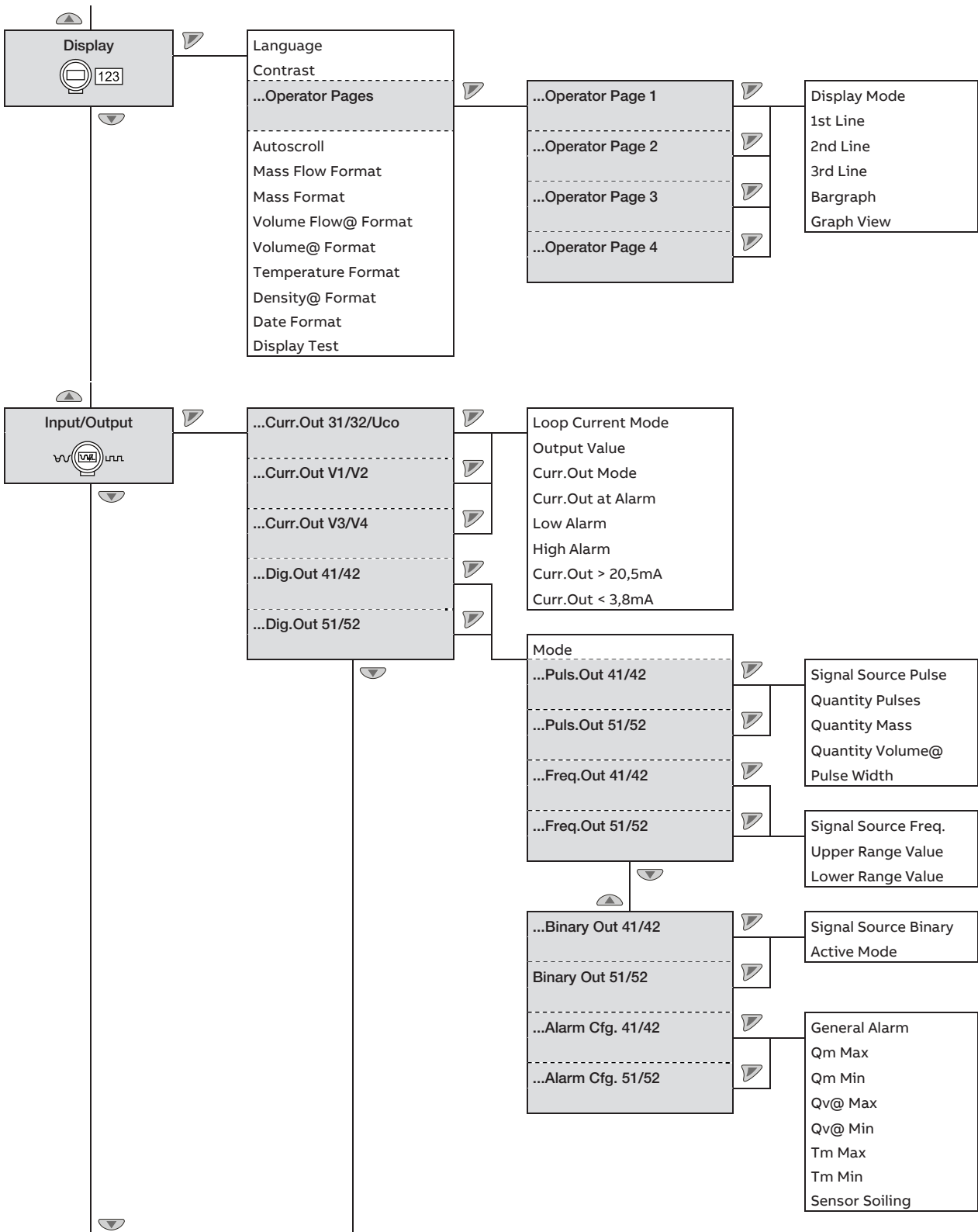

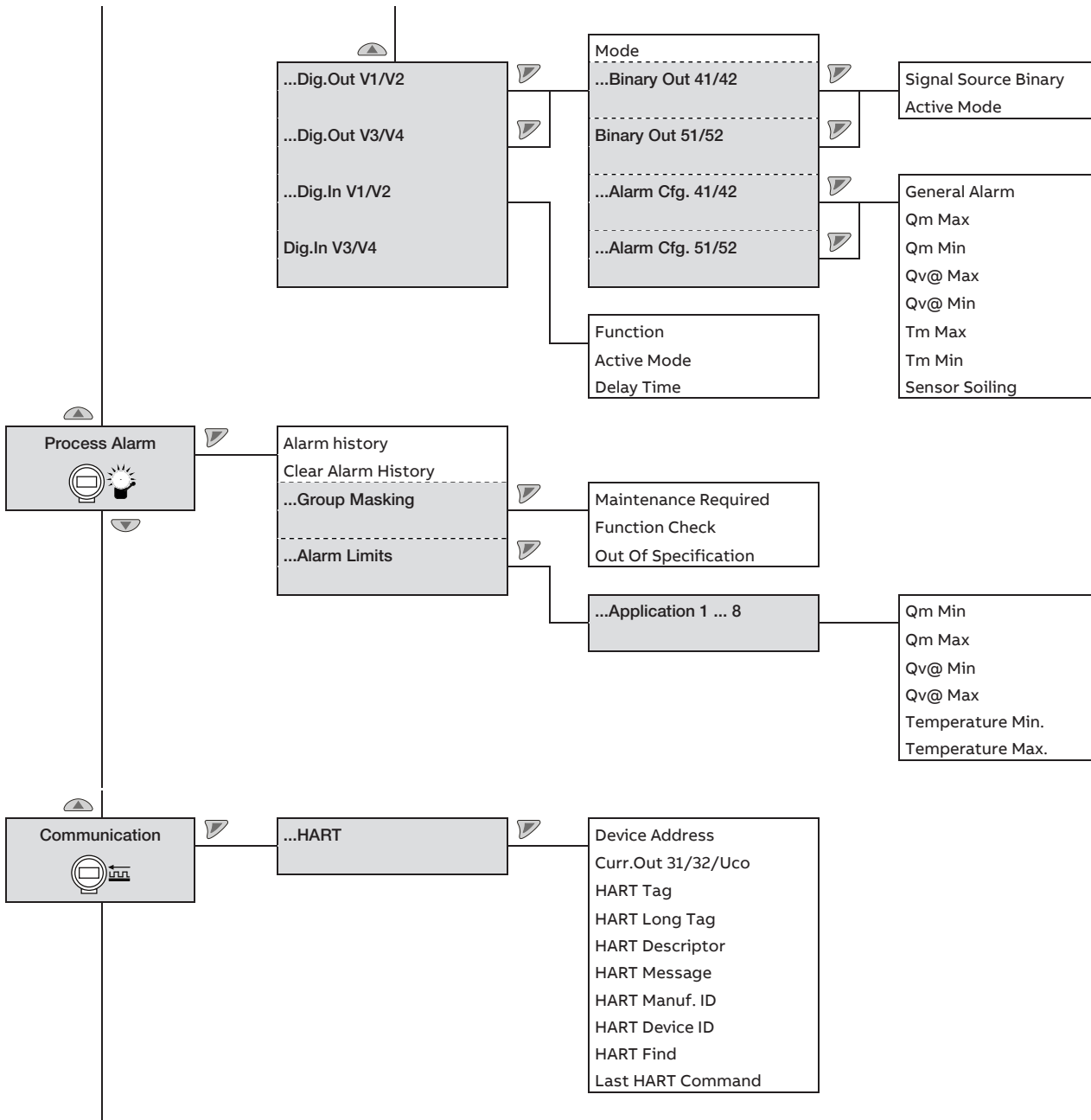

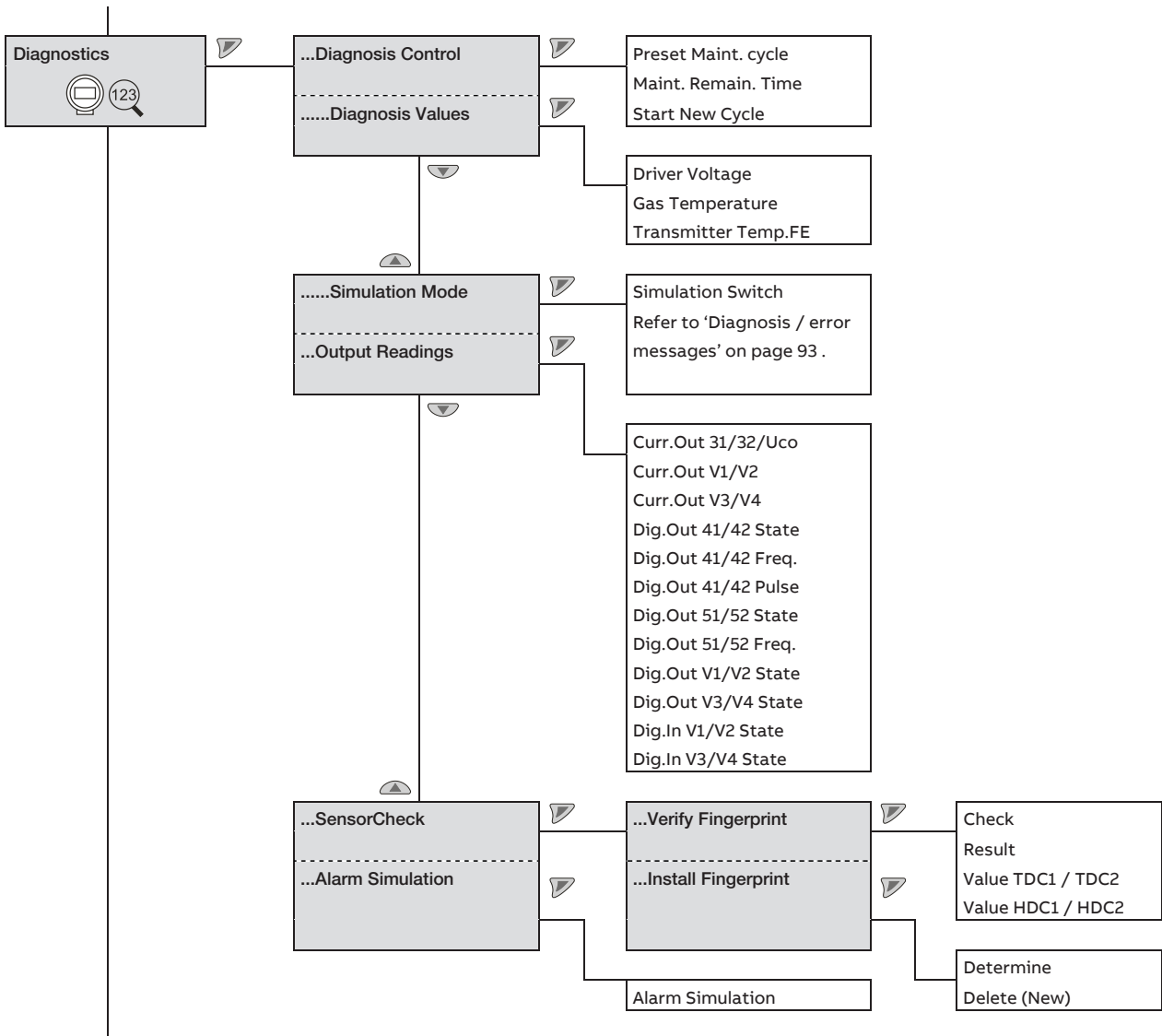

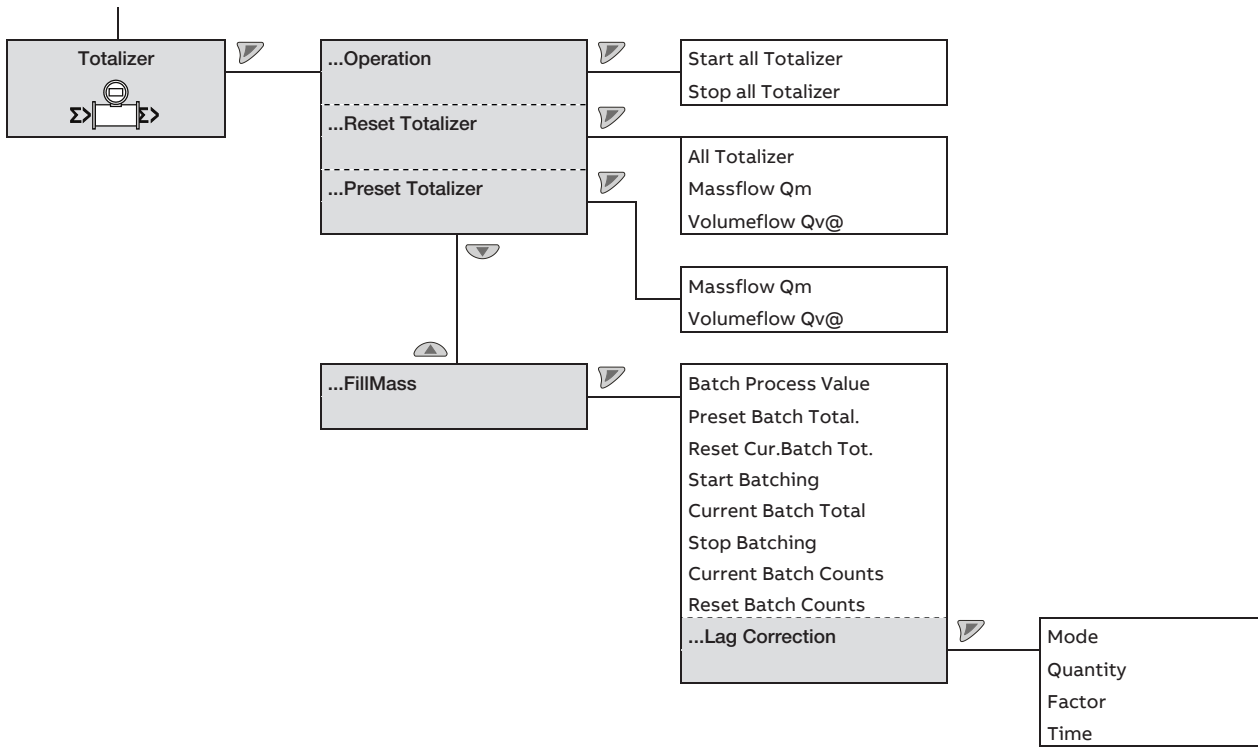

7.5 Parameter descriptions

7.5.1 Available units

For certain parameters it is possible to choose among the following units.

i NOTICE

The "Code" column indicates the value to which the corresponding parameter must be set, e.g. using the communications interface.

Table 1: Units for the standard volume flow

Selection	Code	Description
m ³ /s	13	Cubic meters per second
m ³ /min	14	Cubic meters per minute
m ³ /h	15	Cubic meters per hour
m ³ /d	16	Cubic meters per day
ft ³ /s	29	Cubic feet per second
ft ³ /min	30	Cubic feet per minute
ft ³ /h	31	Cubic feet per hour
ft ³ /d	32	Cubic feet per day
l/s	48	Liters per second
l/min	49	Liters per minute
l/h	50	Liters per hour
l/d	51	Liters per day
xx/yy	254	User-defined unit

Table 2: Units for mass flow

Selection	Code	Description
g/s	1	Grams per second
g/min	2	Grams per minute
g/h	3	Grams per hour
kg/s	5	Kilograms per second
kg/min	6	Kilograms per minute
kg/h	7	Kilograms per hour
kg/d	8	Kilograms per day
lb/s	9	Pounds (avdp) per second
lb/min	10	Pounds (avdp) per minute
lb/h	11	Pounds (avdp) per hour
lb/d	12	Pounds (avdp) per day
t/s	29	Metric tons per second
t/min	30	Metric tons per minute
t/h	31	Metric tons per hour
t/d	32	Metric tons per day
xx/yy	254	User-definable unit

Table 3: Standard density units

Selection	Code	Description
g/cm ³	1	Grams per cubic centimeter
g/m ³	3	Grams per cubic meter
kg/m ³	4	Kilograms per cubic meter
g/l	10	Grams per liter
kg/l	11	Kilograms per liter
lb/ft ³	13	Pounds (avdp) per cubic foot
xx/yy	254	User-definable unit

Table 4: Standard conditions

Code	Description
1	Temperature = 0 °C, pressure = 1.01325 bar
2	Temperature = 20 °C, pressure = 1.01325 bar
3	Temperature = 60°F, pressure = 1.01325 bar
4	Temperature = 70°F, pressure = 1.01325 bar
5	Temperature = 15°C, pressure = 1.01325 bar
6	Temperature = 20°C, pressure = 1.00000 bar
7	Temperature = 25°C, pressure = 1.00000 bar
8	Temperature = 25°C, pressure = 1.01325 bar
9	Temperature = 15°C, pressure = 1.00000 bar
254	User-defined standard conditions

Table 5: Temperature units

Selection	Code	Description
K	1	Kelvin
°C	2	Celsius
°F	3	Fahrenheit

Table 6: Length units

Selection	Code	Description
mm	4	Millimeters
inch	13	in.

Table 7: Units for the mass totalizer

Selection	Code	Description
kg	2	Kilograms
g	3	Grams
t	5	Tons (metric)
lb	8	Pounds (advp)
xx	254	User-definable unit

Table 8: Units for the standard volume totalizer

Selection	Code	Description
m ³	4	Cubic meters
ft ³	7	Cubic feet
l	13	Liters
xx	254	User-definable unit

Table 9: Pressure units

Selection	Code	Description
Pa	1	Pascals
kPa	4	Kilopascals
Bar	8	Bar
mBar	9	Millibar
inH ₂ O@4C	51	Inches water column at 4 °C
mmH ₂ O@4C	54	mm water column at 4 °C
atm	64	Atmospheric gauge pressure
psi	65	Pounds per square inch
kp/cm ²	69	Kilogram-force per cm ²

7.5.2 Available gas types

The devices can be designed for the following gas types.

i NOTICE

The "Code" column indicates the value to which the corresponding parameter must be set, e.g. using the communications interface.

Table: Available gas types

Formula	Code	Description
–	0	No selection
–	1	Air ¹⁾ (only for gas type 1 of one application)
CH ₄	144	Methane ¹⁾
N ₂	181	Nitrogen ¹⁾
CO ₂	72	Carbon dioxide ¹⁾
O ₂	187	Oxygen ¹⁾
H ₂	132	Hydrogen ²⁾
–	153	Natural gas ²⁾
NH ₃	39	Ammonia ²⁾
He	120	Helium ²⁾
Ar	42	Argon ²⁾
C ₃ H ₈	205	Propane ²⁾
C ₂ H ₆	108	Ethane ²⁾
C ₄ H ₁₀	69	Butane ²⁾
C ₂ H ₄	114	Ethene ²⁾
–	48	Biogas ²⁾

- 1) Gas type available in ApplicationSelector (preconfigured applications) and for three configurable applications.
 2) Gas type available only for preonfigured applications.

7.5.3 Available process variables

The process variables available in the software are listed in the table.

Process variables can be assigned to the display (HMI), the current outputs (CO), the frequency outputs (DO [f]), and the pulse outputs (DO [pulse]).

Process variable	Short form	Description	HMI	CO	DO 41 / 52, DO 51 / 52	
					Frequency output	Pulse output
Mass Flow [unit]	Qm	Mass flow in the selected mass flow unit	X	–	–	X
Mass Flow [%]	Qm	Mass flow in percent	X	X	X	–
Qv@ [Unit]	Qv@	Standard volume flow in the selected volume unit	X	–	–	X
Qv@ [%]	Qv@	Standard volume flow in percent	X	X	X	–
Temperature [unit]	Tm	Temperature in the selected standard volume unit	X	–	–	–
Temperature [%]	Tm	Temperature in percent	X	X	X	–
Density@ [unit]	p@	Standard density in the selected density unit	X	–	–	–
Counter Qm	Σm	Mass flow counter reading in the selected unit.	X	–	–	–
Counter Qv@	$\Sigma v@$	Standard volume flow counter reading in the selected unit.	X	–	–	–
Current Batch Total ¹⁾	CBT	Current fill quantity	X	–	–	–
Current Batch Counts ¹⁾	CBC	Number of fill operations	X	–	–	–

1) Process variable is only available if FillMass function is activated.

X = process variable available, – = process variable not available.

7.5.4 Menu: Easy Setup





Menu / parameter	Description
Easy Setup	
Language	Selection of menu language.
Curr.Out 31/32/Uco	Selection of the process value issued via the current output.
Curr.Out V1/V2	The current outputs V1 / V2 and V3 / V4 are only available if the corresponding plug-in cards are present! — Mass Flow [%]: Mass flow in %
Curr.Out V3/V4	— Volume Flow@ [%]: Standard volume flow in % — Temperature [%]: Temperature in %
Freq.Out 41/42	Selection of the process value issued via the frequency output. — Mass Flow [%]: Mass flow in % — Volume Flow@ [%]: Standard volume flow in % — Temperature [%]: Temperature in %
Freq.Out 41/42 0%	Set the frequency range for output of the selected process variables. — Freq.Out 41/42 100%: Set the frequency for 100 % of the process variable.
Freq.Out 41/42 100%	— Freq.Out 41/42 0%: Set the frequency for 0 % of the process variable.
Puls.Out 41/42	Selection of the process value issued via the pulse output. — Mass Flow: Mass flow — Volume Flow@: Standard volume flow
Puls.Out 41/42 Width	Set the pulse width (low signal) for the pulse output.
Bin.Out 41/42	Selection of binary output function. — Alarm: The binary output indicates an active alarm. The alarm is selected in the ",,...Alarm Cfg. 41/42" menu. — Batch End: The binary output is activated when the set fill quantity is reached (only if the FillMass function is activated).
Freq.Out 51/52	Selection of the process value issued via the frequency output. — Mass Flow [%]: Mass flow in % — Volume Flow@ [%]: Standard volume flow in % — Temperature [%]: Temperature in %
Freq.Out 51/52 0%	Set the frequency range for output of the selected process variables. — Freq.Out 51/52 100%: Set the frequency for 100 % of the process variable.
Freq.Out 51/52 100%	— Freq.Out 51/52 0%: Set the frequency for 0 % of the process variable.

Menu / parameter	Description
Easy Setup	
Binary Out 51/52	<p>Selection of binary output function.</p> <ul style="list-style-type: none"> — Alarm: The binary output indicates an active alarm. The alarm is selected in the "...Alarm Cfg. 51/52" menu. — Batch End: The binary output is activated when the set fill quantity is reached (only if the FillMass function is activated).
Binary Out V1/V2	<p>Selection of binary output function.</p> <ul style="list-style-type: none"> — Alarm: The binary output indicates an active alarm. The alarm is selected in the "...Alarm Cfg. 51/52" menu. — Batch End: The binary output is activated when the set fill quantity is reached (only if the FillMass function is activated).
Binary Out V3/V4	<p>Selection of binary output function.</p> <ul style="list-style-type: none"> — Alarm: The binary output indicates an active alarm. The alarm is selected in the "...Alarm Cfg. 51/52" menu. — Batch End: The binary output is activated when the set fill quantity is reached (only if the FillMass function is activated).
Application	<p>Application selection (type of measuring medium)</p> <ul style="list-style-type: none"> — Application 1 ... 8: Selection of the appropriate application. The individual applications are configured in the "Device Setup / ...Sensor / ...Application 1 ... 8" menu.
Dig.In 0 Application	Use of optional digital inputs for application switching. You can switch between four applications by wiring the digital inputs.
Dig.In 1 Application	<ul style="list-style-type: none"> — Dig.In 0 Application: Assignment of the application if no digital inputs are active. — Dig.In 1 Application: Assignment of the application if only digital input V1 / V2 is active.
Dig.In 2 Application	<ul style="list-style-type: none"> — Dig.In 2 Application: Assignment of the application if only digital input V3 / V4 is active. — Dig.In1+2Application: Assignment of the application if only digital input V1 / V2 and V3 / V4 are active.
Dig.In1+2Application	<p>NOTICE</p> <p>The function is available only with the corresponding plug-in cards in place! The digital inputs must be configured in the "Input/Output / ...Dig.In V1/V2" or "Input/Output / ...Dig.In V1/V2" menu using the "Act. App.Selector1 3" function or "Act. App.Selector2 3" function.</p>

Menu / parameter	Description
Unit Massflow Qm	Selection of unit for mass flow. Refer to 'Table 2: Units for mass flow' on page 65. The selection applies to the display of the current mass flow, and for the parameters related to mass flow such as Qm _{Max} and Qm _{Max} DN.
Qm Max	Set the upper range value for the mass flow.
Unit Volumeflow Qv@	Selection of unit for the standard volume flow. Refer to 'Table 1: Units for the standard volume flow' on page 65. The selection applies to the display of the current standard volume flow and for the parameters related to standard volume flow such as Qv@ Max and Qv@ Max. DN.
Std. Conditions Vol@	Selection of the standard state for standard volume flow. 'Table 4: Standard conditions' on page 65
Qv@ Max	Set the upper range value for standard volume flow.
Unit Temperature	Selection of unit for temperature (e.g. for the associated parameters and the corresponding process values). 'Table 5: Temperature units' on page 65
Tm Max	Set the upper range value for the measuring medium temperature.
Tm Min	Set the lower range value for the measuring medium temperature.
Mass Totalizer	Selection of the unit for the mass counters and the pulse outputs. 'Table 7: Units for the mass totalizer' on page 65
Volume Totalizer	Selection of the unit for the volume totalizers and the pulse outputs. 'Table 8: Units for the standard volume totalizer' on page 65
Damping Q	Select the damping for flow measurement. The value set here relates to 1τ (Tau). The value refers to the response time for a step flowrate change. It affects the instantaneous value in the display and at the current output. Default setting: 0.2 seconds
Low Flow Cut Off	Set the switching threshold (0 ... 10 %) for the low flow cut-off. If the flow rate is below the switching threshold, there is no flow measurement. The setting of 0 % deactivates the low flow cut-off. Default setting: 0 %

7.5.5 Menu: Device Info





This menu is only used to display the device parameters. The parameters are displayed independently of the configured access level, but cannot be changed.

Menu / parameter	Description
Device Info	
...Sensor	Selection of submenu "...Sensor" using  .
...Application Selector	Selection of submenu "...Application Selector" using  .
...Application 1	Selection of submenu "...Application 1" ... "...Application 8" using  .
...	
...Application 8	
...Transmitter	Selection of submenu "...Transmitter" using  .



Device Info / ...Sensor	
Sensor Location Tag	Display of the measuring point tagging for the sensor.
Sensor Tag	Display of the tag number for the sensor.
Sensor Element Type	Display of the design of the thermal measuring element.
Sensor Length	Display of the insertion length of the sensor.
Feature Series	Display of the device family.
Sensor ID	Display of the sensor ID.
Sensor Serial No.	Display of the sensor serial number.
Sensor Run Hours	Display of the operating hours of the sensor.
...Calibration	Selection of submenu "...Calibration" using  .

Device Info / ...Sensor / ...Calibration	
First Cal. Date	Display of the calibration data of the sensor.
Last Cal. Date	
Cal. Cert. No.	
First Cal. Location	
Last Cal. Location	





Device Info / ...Application Selector	
Application	Display of the selected application (type of measuring medium).
Dig.In 0 Application	Display of the application assignment to the optional digital inputs.
Dig.In 1 Application	
Dig.In 2 Application	
Dig.In1+2Application	





Menu / parameter	Description
Device Info / ...Sensor / ...Application 1	
...	
Device Info / ...Sensor / ...Application 8	
Description	Display of the name of the application 1 ... 8.
...A1...Flow meas.	Selection of submenu "...A8...Flow meas." ... "...A8...Flow meas." using  .
...	
...A8...Flow meas.	
...A1...Temp. meas.	Selection of submenu "...A8...Temp. meas." ... "...A8...Flow meas." using  .
...	
...A8...Temp. meas.	
...A1...Pipe type	Selection of submenu "...A8...Pipe type" ... "...A8...Flow meas." using  .
...	
...A8...Pipe type	
...A1...Gas data	Selection of submenu "...A8...Gas data" ... "...A8...Flow meas." using  .
...	
...A8...Gas data	
...A1...Field Optim.	Selection of submenu "...A8...Field Optim." ... "...A8...Flow meas." using  .
...	
...A1...Field Optim.	
Device Info / ...Sensor / ...Application 1 / ...A1...Flow meas.	
...	
Device Info / ...Sensor / ...Application 8 / ...A8...Flow meas.	
Qm Max. DN	Display of the maximum mass flow for the selected nominal diameter.
Qm Max	Display of the upper range value for the mass flow.
Qm Min	Display of the lower range value for the mass flow.
Qv@ Max. DN	Display of the maximum standard volume flow for the selected nominal diameter.
Qv@ Max	Display of the upper range value for the standard volume flow.
Qv@ Min	Display of the lower range value for the standard volume flow.
Damping Q	Display of the damping for flow measurement.
Low Flow Cut Off	Display of the switching threshold (0 ... 10 %) for the low flow cut-off.
LowFlow Hysteresis	Display of the hysteresis (0 ... 50 %) for the low flow cut-off.

Menu / parameter	Description
Device Info / ...Sensor / ...Application 1 / ...A1...Temp. meas.	
...	
Device Info / ...Sensor / ...Application 8 / ...A8...Temp. meas.	
Tm Max	Display of the upper range value for the measuring medium temperature.
Tm Min	Display of the lower range value for the measuring medium temperature.
Damping Tm	Display of the damping for temperature measurement.
Device Info / ...Sensor / ...Application 1 / ...A1...Pipe type	
...	
Device Info / ...Sensor / ...Application 8 / ...A8...Pipe type	
Shape and probe pos.	Display of the piping form and sensor position.
Inside diameter	Display of the inside diameter of the piping.
Duct inner height	Display of the inside height of the channel with rectangular cross-section.
Insertion depth	Display of the insertion depth of the sensor.
Duct inner width	Display of the inside width of the channel with rectangular cross-section.
Device Info / ...Sensor / ...Application 1 / ...A1...Gas data	
...	
Device Info / ...Sensor / ...Application 8 / ...A8...Gas data	
Mean Operating Temp.	Display of the average measuring medium temperature.
Mean Operating Press	Display of the average measuring medium pressure.
Gas Type 1	Display of the gas type for gas components 1 ... 10 of a gas mix.
...	See table 'Available gas types' on page 66.
Gas Type 10	
Concentr. Gas Type 1	Display of the concentration in % for gas components 1 ... 10 of a gas mix.
...	
Concentr. Gas Type 10	
Device Info / ...Sensor / ...Application 1 / ...A1...Field Optim.	
...	
Device Info / ...Sensor / ...Application 8 / ...A8...Field Optim.	
Offset Qm	Offset correction of the flow rate measured value.
Corr.Factor Qm	Correction factor for the flow measured value.



Menu / parameter	Description
Device Info / ...Transmitter	
Transmitter Type	Display of the transmitter design.
Transmitter ID	Display of the transmitter ID.
Transm.Serial No.	Display of the transmitter serial number.
...Transmitter Version	Selection of submenu "...Transmitter Version" using  .
Transm. Run Hours	Display of the operating hours of the transmitter.
Tx Restart Counter	Number of device restarts (switching the power supply off and on).
Time since Restart	Device operating hours since the last restart.
FillMass On/Off	FillMass function active?
VeriMass On/Off	VeriMass function active?
...Calibration	Selection of submenu "...Calibration" using  .
Manufacturer	Display of the manufacturer address and telephone number.
Street	
City	
Phone	
Device Info / ...Transmitter / ...Transmitter Version	
FW Device Ver.	Version and item number of device software package.
FW Device Part Nr.	
FW Motherboard Ver.	Version and checksum (CRC) of the motherboard software (MB) in the transmitter.
FW Motherboard CRC	
FW Frontend Ver.	Version and checksum (CRC) of the frontend board (FEB) software in the sensor.
FW Frontend CRC	
HW Motherboard Ver.	Hardware version of the motherboard (MB) in the transmitter.
HW Frontend Ver.	Hardware version of the frontend board (FEB) in the sensor.
Bootloader MB Ver.	Version of the motherboard bootloader in the transmitter.
Bootloader FEB Ver.	Version of the frontend board bootloader in the sensor.
Curr. Out FW Ver.	Current output module software version and checksum (CRC).
Curr. Out FW CRC	
Option Card 1 FW Ver	Version and test number (CRC) of the software of the optional plug-in cards.
Option Card 1 FW CRC	
Option Card 2 FW Ver	
Option Card 2 FW CRC	
Device Info / ...Transmitter / ...Calibration	
First Cal. Date	Display of the calibration data of the transmitter.
Last Cal. Date	
Cal. Cert. No.	
First Cal. Location	
Last Cal. Location	

7.5.6 Menu: Device Setup

Menu / parameter	Description
Device Setup	
...Access Control	Selection of submenu "...Access Control" using  .
...Sensor	Selection of submenu "...Sensor" using  .
...Application Selector	Selection of submenu "...Application Selector" using  .
...Application 1	Selection of submenu "...Application 1" ... "...Application 8" using  .
...	
...Application 8	
...Transmitter	Selection of submenu "...Transmitter" using  .
Device Setup / ...Access Control	
Standard Password	Entry / change of the password for the "Standard" access level.
Read Only Switch	Indicator of the position of the write protection switch. For further information, see chapter 'Hardware settings' on page 42.
Device Setup / ...Sensor	
Sensor Location Tag	Enter the measuring point tagging for the sensor. The measuring point tagging is shown in the header of the process display. Alphanumeric, max. 20 characters
Sensor Tag	Enter the tag number for the sensor. Alphanumeric, max. 20 characters
Device Setup / ...Application Selector	
Application	Application selection (type of measuring medium) — Application 1 ... 8: Selection of the appropriate application. The individual applications are configured in the "Device Setup / ...Sensor / ...Application 1 ... 8" menu.
Dig.In 0 Application	Use of optional digital inputs for application switching. You can switch between four applications by wiring the digital inputs. — Dig.In 0 Application: Assignment of the application if no digital inputs are active. — Dig.In 1 Application: Assignment of the application if only digital input V1 / V2 is active. — Dig.In 2 Application: Assignment of the application if only digital input V3 / V4 is active. — Dig.In1+2Application: Assignment of the application if only digital input V1 / V2 and V3 / V4 are active. NOTICE The function is available only with the corresponding plug-in cards in place! The digital inputs must be configured in the "Input/Output / ...Dig.In V1/V2" or "Input/Output / ...Dig.In V3/V4" menu using the "Act. App.Selector1[3]" function or "Act. App.Selector2[3]" function.
Dig.In 1 Application	
Dig.In 2 Application	
Dig.In1+2Application	







Menu / parameter	Description
Device Setup / ...Sensor / ...Application 1	
...	
Device Setup / ...Sensor / ...Application 8	
Description	Enter the description for Application 1 ... 8. Alphanumeric, max. 32 characters
...A1...Flow meas.	Selection of submenu "...A1...Flow meas." ... "...A8...Flow meas." using  .
...	
...A8...Flow meas.	
...A1...Temp. meas.	Selection of submenu "...A1...Flow meas." ... "...A8...Flow meas." using  .
...	
...A8...Temp. meas.	
...A1...Pipe type	Selection of submenu "...A1...Flow meas." ... "...A8...Flow meas." using  .
...	
...A8...Pipe type	
...A1...Gas data	Selection of submenu "...A1...Flow meas." ... "...A8...Flow meas." using  .
...	
...A8...Gas data	
...A1...Field Optim.	Selection of submenu "...A1...Flow meas." ... "...A8...Flow meas." using  .
...	
...A1...Field Optim.	
Device Setup / ...Sensor / ...Application 1 / ...A1...Flow meas.	
...	
Device Setup / ...Sensor / ...Application 8 / ...A8...Flow meas.	
Qm Max. DN	Display of the maximum mass flow for each application.
Qm Max	Set the upper range value for the mass flow.
Qm Min	Set the lower range value for the mass flow.
Qv@ Max. DN	Display of the maximum standard volume flow for each application.
Qv@ Max	Set the upper range value for standard volume flow.
Qv@ Min	Set the lower range value for standard volume flow.
Damping Q	Select the damping for flow measurement. The value set here relates to 1τ (Tau). The value refers to the response time for a step flowrate change. It affects the instantaneous value in the display and at the current output. Default setting: 0.2 seconds
Low Flow Cut Off	Set the switching threshold (0 ... 10 %) for the low flow cut-off. If the flow rate is below the switching threshold, there is no flow measurement. The setting of 0 % deactivates the low flow cut-off. Default setting: 0 %
LowFlow Hysteresis	Set the hysteresis (0 ... 50 %) for the low flow cut-off as it is defined in the parameter "Low Flow Cut Off". Default setting: 0 %

Menu / parameter	Description
Device Setup / ...Sensor / ...Application 1 / ...A1...Temp. meas.	
...	
Device Setup / ...Sensor / ...Application 8 / ...A8...Temp. meas.	
Tm Max	Set the upper range value for the measuring medium temperature.
Tm Min	Set the lower range value for the measuring medium temperature.
Damping Tm	Select the damping for temperature measurement. The value set here relates to 1τ (Tau). The data refers to the response time for an abrupt change in temperature. It affects the instantaneous value in the display and at the current output. Default setting: 0.2 seconds
Device Setup / ...Sensor / ...Application 1 / ...A1...Pipe type	
...	
Device Setup / ...Sensor / ...Application 8 / ...A8...Pipe type	
Shape and probe pos.	Select the piping form and sensor position. A: Circular and centered B: Circular C: Rectangular
Inside diameter	Set the inside diameter of the piping. Visible only when A and B selected.
Duct inner height	Set the inside height of the channel with rectangular cross-section. Visible only when C selected.
Insertion depth	Set the insertion depth of the sensor. Visible only when B and C selected.
Duct inner width	Set the inside width of the channel with rectangular cross-section. Visible only when C selected.
Device Setup / ...Sensor / ...Application 1 / ...A1...Gas data	
...	
Device Setup / ...Sensor / ...Application 8 / ...A8...Gas data	
Mean Operating Temp.	Set the average measuring medium temperature.
Mean Operating Press	Set the average measuring medium pressure.
Gas Type 1	Select gas type for gas components 1 ... 10 of a gas mix.
...	See table 'Available gas types' on page 66.
Gas Type 10	
Concentr. Gas Type 1	Set concentration in % for gas components 1 ... 10 of a gas mix.
...	
Concentr. Gas Type 10	
Device Setup / ...Sensor / ...Application 1 / ...A1...Field Optim.	
...	
Device Setup / ...Sensor / ...Application 8 / ...A8...Field Optim.	
Offset Qm	Offset correction of the flow rate measured value.
Corr.Factor Qm	Correction factor for the flow measured value.









Menu / parameter	Description
Device Setup / ...Transmitter	
...Units	Selection of submenu "...Units" using  .
...Custom Units	Selection of submenu "...Custom Units" using  .
TX Location TAG	Entry of the measuring point tag for the transmitter. Alphanumeric, max. 20 characters
TX TAG	Entry of the TAG number for the transmitter. Alphanumeric, max. 20 characters
Perform Device Reset	For service purposes only. Restart the device without having to switch the power supply on and off.
Factory Defaults	All user-accessible parameters will be reset to the factory default settings.
...Feature Settings	Selection of submenu "...Feature Settings" using  .
Device Setup / ...Transmitter / ...Units	
Unit Massflow Qm	Selection of unit for mass flow. Refer to 'Table 2: Units for mass flow' on page 65. The selection applies to the display of the current mass flow, and for the parameters related to mass flow such as $Q_{m_{Max}}$ and $Q_{m_{Max}DN}$.
Mass Totalizer	Select the unit for the mass totalizer. Refer to 'Table 7: Units for the mass totalizer' on page 65.
Unit Volumeflow Qv@	Selection of unit for the standard volume flow. Refer to 'Table 1: Units for the standard volume flow' on page 65. The selection applies to the display of the current standard volume flow and for the parameters related to standard volume flow such as $Q_{v@ Max}$ and $Q_{v@ Max. DN}$.
Unit Vol.@ totalizer	Select the unit for the standard volume totalizer. Refer to 'Table 8: Units for the standard volume totalizer' on page 65.
Std. Conditions Vol@	Selection of the standard state for standard volume flow. Refer to 'Table 4: Standard conditions' on page 65.
Volumeflow Qv@ Name	Enter the name of the unit for the standard volume flow. If the first character is a space, a @ sign will be appended to the unit (standard setting). Alphanumeric, maximum 7 characters.
Volume@ Tot. Name	Enter the name of the unit for the standard volume totalizer. If the first character is a space, a @ sign will be appended to the unit (standard setting). Alphanumeric, maximum 7 characters.
Temperature	Selection of unit for temperature. Refer to 'Table 5: Temperature units' on page 65.
Pressure	Select a unit for pressure. Refer to 'Table 9: Pressure units' on page 65.
Length	Select a unit for length information. Refer to 'Table 6: Length units' on page 65.
Density@	Select a unit for standard density. Refer to 'Table 3: Standard density units' on page 65.
Density@ Name	Enter the name of the unit for standard density. If the first character is a space, a @ sign will be appended to the unit (standard setting). Alphanumeric, maximum 7 characters.

Menu / parameter	Description
Device Setup / ...Transmitter / ...Custom Units	
Mass flow Qm Name	Enter the name of the user-defined unit for mass flow. Alphanumeric, maximum 7 characters.
Mass flow Qm Factor	Enter the factor for the user-defined unit for mass flow. Setting range: 0.0001 ... 100000 kg/h
Mass Tot. Name	Enter the name of the user-defined totalizer unit for mass flow. Alphanumeric, maximum 7 characters.
Mass Tot. Factor	Enter the factor for a user-defined totalizer unit. Setting range: 0.0001 ... 100000 kg
Volumeflow Qv@ Name	Enter the name of the user-defined unit for standard volume flow. Alphanumeric, maximum 7 characters.
Volumeflow Qv@ Fact.	Enter the factor for the user-defined unit for standard volume flow. Setting range: 0.0001 ... 100000 m ³ /hour in standard conditions.
Volume@ Tot. Name	Enter the name of the user-defined totalizer unit for standard volume flow. Alphanumeric, maximum 7 characters.
Volume@ Tot. Factor	Enter the factor for the user-defined totalizer unit for standard volume flow. Setting range: 0.0001 ... 100000 m ³ in standard conditions.
Density@ Name	Enter the name of the user-defined unit for standard density. Alphanumeric, maximum 7 characters.
Density@ Factor	Enter the factor of the user-defined unit for standard density. Setting range: 0.0001 ... 100000 kg/m ³ in standard conditions.
Device Setup / ...Transmitter / ...Feature Settings	
FillMass On/Off	FillMass function active? Off: FillMass function deactivated. On: FillMass function activated.
FillMass Code	Sets the device-specific code for activating the FillMass function. To use this function subsequently, contact the ABB service team or sales organization.
VeriMass On/Off	VeriMass function active? Off: VeriMass function deactivated. On: VeriMass function activated.
VeriMass Code	Sets the device-specific code for activating the VeriMass function. To use this function subsequently, contact the ABB service team or sales organization.

7.5.7 Menu: Display

Menu / parameter	Description
Display	
Language	Selection of menu language. Available languages: English, Deutsch
Contrast	Contrast setting for the LCD display.
...Operator Pages	Selection of submenu "...Operator Pages" using  . Up to four user-specific operator pages (layouts) can be configured for the process display. If multiple operator pages have been configured, these can be scrolled through manually on the information level. In the factory setting only Operator Page 1 is enabled.
Autoscroll	If Autoscroll is enabled, the "Autoscroll" function can also be activated on the information level of the operator menu. In this function, operator pages are automatically displayed in succession on the process screen, changing every 10 seconds. Manual scrolling through pre-configured operator pages as described above is no longer necessary. When Auto scroll mode is enabled, the icon  is displayed in the lower left corner of the screen. Default setting: Disabled.
Mass Flow Format	Selection of number of decimal places (maximum 12) used to display the corresponding process variables.
Mass Format	
Volume Flow@ Format	
Volume@ Format	
Temperature Format	
Density@ Format	
Date Format	Select the display format for the date.
Display Test	Start the test of the LCD display with "  ". The display test lasts approx. 10 seconds. Various patterns are shown on the LCD display to check the display.
Display / ...Operator Pages	
...Operator Page 1	Selection of submenu "...Operator Page 1" using  .
...Operator Page 2	Selection of submenu "...Operator Page 2" using  .
...Operator Page 3	Selection of submenu "...Operator Page 3" using  .
...Operator Page 4	Selection of submenu "...Operator Page 4" using  .
Display / ...Operator Pages / ...Operator Page 1 (n)	
Display Mode	Configure each operator page. The following versions can be selected: Off, Graph View (Only for user page 1), 1x4, 1x6A, 1x6A Bar, 1x9, 1x9 Bar, 2x9, 2x9 Bar, 3x9. Selecting "Off" deactivates the corresponding operator page.
1st Line	Selection of process variable displayed in the respective row. See table 'Available process variables' on page 67.
2nd Line	
3rd Line	
4th Line	
Bargraph	Select the process variable displayed as a bar graph (only in display modules with "Bar" bar graph). See table 'Available process variables' on page 67.
Graph View	Select the process variable displayed as a graphic view (available only for user page 1). See table 'Available process variables' on page 67.

7.5.8 Menu: Input/Output

Menu / parameter	Description
Input/Output	
...Curr.Out 31/32/Uco	Selection of submenu "...Curr.Out 31/32/Uco" using  .
...Curr.Out V1/V2	Selection of submenu "...Curr.Out V1/V2" using  .
...Curr.Out V3/V4	Selection of submenu "...Curr.Out V3/V4" using  .
...Dig.Out 41/42	Selection of submenu "...Dig.Out 41/42" using  .
...Dig.Out 51/52	Selection of submenu "...Dig.Out 51/52" using  .
...Dig.Out V1/V2	Selection of submenu "...Dig.Out V1/V2" using  .
...Dig.Out V3/V4	Selection of submenu "...Dig.Out V3/V4" using  .
...Dig.In V1/V2	Selection of submenu "...Dig.In V1/V2" using  .
...Dig.In V3/V4	Selection of submenu "...Dig.In V3/V4" using  .





Input/Output / ...Curr.Out 31/32/Uco



Input/Output / ...Curr.Out V1/V2

Input/Output / ...Curr.Out V3/V4



The outputs V1 / V2 and V3 / V4 are only available if the corresponding plug-in cards are present!

Loop Current Mode	<p>Display of the HART operating mode (only for 31 / 32 Uco current output).</p> <ul style="list-style-type: none"> — Multidrop Fixed: The current output supports the HART multi-drop mode, the current output is fixed to 3.6 mA and no longer follows the selected process variable. The process variables can be transferred via the HART protocol. — Normal Signaling: The current output transfers the selected process variables. In addition, the process variables can be transferred via the HART protocol.
Output Value	<p>Selection of the process variable issued at the corresponding current output.</p> <p>See table 'Available process variables' on page 67.</p>
Curr.Out at Alarm	<p>Selection of status of the current output in error condition.</p> <p>The output "low" or "high" current is set in the subsequent menu.</p>
Low Alarm	Sets the current for Low Alarm.
High Alarm	Sets the current for High Alarm.
Curr.Out > 20,5mA	<p>Behavior of current output if 20.5 mA is exceeded.</p> <ul style="list-style-type: none"> — Hold Last Value: The last measured value is retained and issued. — High Alarm: The high alarm current is issued. — Low Alarm: The low alarm current is issued.
Curr.Out < 3,8mA	<p>Behavior of the current output if 3.8 mA is not reached.</p> <ul style="list-style-type: none"> — Hold Last Value: The last measured value is retained and issued. — High Alarm: The high alarm current is issued. — Low Alarm: The low alarm current is issued.



Menu / parameter	Description
Input/Output / ...Dig.Out 41/42	
Mode	<p>Selection of the operating mode for the digital output 41 / 42.</p> <ul style="list-style-type: none"> — Off: Digital output 41 / 42 deactivated. — Binary: Digital output 41 / 42 as a binary output (e.g. as an alarm output). — Pulse: Digital output 41 / 42 as a pulse output. In pulse mode, pulses per unit are output (e.g. 1 pulse per kg). — Frequency: Digital output 41 / 42 as a frequency output. In frequency mode, a frequency proportional to the selected process variable is output.
...Puls.Out 41/42	<p>Selection of submenu "...Puls.Out 41/42" using  .</p> <p>Only available if "Mode" Pulse has been selected.</p>
...Freq.Out 41/42	<p>Selection of submenu "...Freq.Out 41/42" using  .</p> <p>Only available if "Mode" Frequency has been selected.</p>
...Binary Out 41/42	<p>Selection of submenu "...Binary Out 41/42" using  .</p> <p>Only available if "Mode" Binary has been selected.</p>
...Alarm Cfg. 41/42	<p>Selection of submenu "...Alarm Cfg. 41/42" using  .</p> <p>Only available when "Mode" Binary is selected in the "...Binary Out 41/42 / Signal Source Binary" Alarm menu.</p>
Input/Output / ...Dig.Out 41/42 / ...Puls.Out 41/42	
Signal Source Pulse	<p>Select process variable that is issued via the pulse output.</p> <p>See table 'Available process variables' on page 67.</p>
Quantity Pulses	Set the pulses per mass unit or volume unit (see table 'Available units' on page 65) for the pulse output.
Quantity Mass	The pulse value is a result of the ratio of "Quantity Pulses" per "Quantity Mass" or "Quantity Pulses" per
Quantity Volume@	"Quantity Volume@".
Pulse Width	<p>Set the pulse width (low signal) for the pulse output.</p> <p>The parameter directly limits the maximum possible output rate of pulses, e.g. max. 500 pulses/sec at 1 ms. If the calculation of the current output rate leads to an up-scale, the pulses are buffered and output with a delay.</p> <p>Setting range: 0.05 ... 2000 ms</p>
Input/Output / ...Dig.Out 41/42 / ...Freq.Out 41/42	
Signal Source Freq.	<p>Selection of process variable that is issued via the frequency output.</p> <p>See table 'Available process variables' on page 67.</p>
Upper Range Value	Set the frequency range for output of the selected process variables.
Lower Range Value	<ul style="list-style-type: none"> — Upper Range Value: Set the frequency for 100 % of the process variable. — Lower Range Value: Set the frequency for 0 % of the process variable.

Menu / parameter	Description
Input/Output / ...Dig.Out 41/42 / ...Binary Out 41/42	
Signal Source Binary	Selection of binary output function. — Alarm: The binary output indicates an active alarm. The alarm is selected in the "...Alarm Cfg. 41/42" menu. — Batch End: The binary output is activated when the set fill quantity is reached (only if the FillMass function is activated).
Active Mode	Select switching properties for the binary output. — Active High: Normally open — Active Low: Normally closed
Input/Output / ...Dig.Out 41/42 / ...Alarm Cfg. 41/42	
General Alarm	Selection of error messages signaled via the binary output 41 / 42.
Qm Massflow Max	Only if the parameter "Signal Source Binary" has been set to "Alarm".
Qm Massflow Min	
Qv@ Volumeflow Max	
Qv@ Volumeflow Min	
Tm Max	
Tm Min	
Sensor Soiling	
Input/Output / ...Dig.Out 51/52	
Mode	Selection of the operating mode for the digital output 51 / 52. The following operating mode Pulse 41/42 <)90°, Pulse 41/42 <)180°" is only available if the digital output 41 / 42 has been configured as a pulse output. — Off: Digital output deactivated. — Binary: Digital output functions as binary output (for function see parameter "...Binary Out 51/52"). — Frequency: Digital output 51 / 52 as a frequency output. In frequency mode, a proportional frequency is issued. — Pulse 41/42 <)90°: 90° phase-shifted output of the same pulses as for digital output 41 / 42. — Pulse 41/42 <)180°: 180° phase-shifted output of the same pulses as for digital output 41 / 42.
...Freq.Out 51/52	Selection of submenu "...Freq.Out 51/52" using  . Only available if "Mode" Frequency has been selected.
...Binary Out 51/52	Selection of submenu "...Binary Out 51/52" using  . Only available if "Mode" Binary has been selected.
...Alarm Cfg. 51/52	Selection of submenu "...Alarm Cfg. 51/52" using  . Only available if "Mode" Binary has been selected.

Menu / parameter	Description
Input/Output / ...Dig.Out 51/52 / ...Freq.Out 51/52	
Signal Source Freq.	Selection of process variable that is issued via the frequency output. See table 'Available process variables' on page 67.
Upper Range Value	Set the frequency range for output of the selected process variables.
Lower Range Value	— Upper Range Value: Set the frequency for 100 % of the process variable. — Lower Range Value: Set the frequency for 0 % of the process variable.
Input/Output / ...Dig.Out 51/52 / ...Binary Out 51/52	
Signal Source Binary	Selection of binary output function. — Alarm: The binary output indicates an active alarm. The alarm is selected in the "...Alarm Cfg. 51/52" menu. — Batch End: The binary output is activated when the set fill quantity is reached (only if the FillMass function is activated).
Active Mode	Select switching properties for the binary output. — Active High: Normally open — Active Low: Normally closed
Input/Output / ...Dig.Out 51/52 / ...Alarm Cfg. 51/52	
General Alarm	Selection of error messages signaled via the binary output 51 / 52.
Qm Massflow Max	Only if the parameter "Signal Source Binary" has been set to "Alarm".
Qm Massflow Min	
Qv@ Volumeflow Max	
Qv@ Volumeflow Min	
Tm Max	
Tm Min	
Sensor Soiling	

Menu / parameter	Description
Input/Output / ...Dig.Out V1/V2 Input/Output / ...Dig.Out V3/V4	
Mode	Selection of operating mode for the digital output V1 / V2 or V3 / V4. — Off: Digital output deactivated. — Binary: Digital output functions as binary output (for function see parameter "...Binary Out V1/V2 / V3/V4"). The digital outputs V1 / V2 and V3 / V4 are only available if the corresponding plug-in cards are present!
...Binary Out V1/V2 / V3/V4	Selection of submenu "...Binary Out V1/V2 / V3/V4" using  . Only available if "Mode" Binary has been selected.
...Alarm Cfg. V1/V2 / V3/V4	Selection of submenu "...Alarm Cfg. V1/V2 / V3/V4" using  . Only available if "Mode" Binary has been selected.
Input/Output / ...Dig.Out V1/V2 / ...Binary Out V1/V2 Input/Output / ...Dig.Out V3/V4 / ...Binary Out V3/V4	
Signal Source Binary	Selection of binary output function. See description "...Input/Output / ...Dig.Out 41/42 / ...Binary Out 41/42".
Active Mode	Select switching properties for the binary output. — Active High: Normally open — Active Low: Normally closed
Input/Output / ...Dig.Out V1/V2 / ...Alarm Cfg. V1/V2 Input/Output / ...Dig.Out V3/V4 / ...Alarm Cfg. V3/V4	
General Alarm	Select error messages signaled via the binary output V1 / V2 or V3 / V4.
Qm Massflow Max	Only if the parameter "Signal Source Binary" has been set to "Alarm".
Qm Massflow Min	
Qv@ Volumeflow Max	
Qv@ Volumeflow Min	
Tm Max	
Tm Min	
Sensor Soiling	
Input/Output / ...Dig.In V1/V2 Input/Output / ...Dig.In V3/V4	
Function	Select a function for the digital input. — Off: No function. — Reset all Totalizer: Counter reset for all counters — Stop all Totalizer: External counter stop for all counters — Set Flowrate to zero: Sets flow measurement to 0. Heating of the thermal measuring element is also switched off here — Start/Stop Batching: Start / stop fill operation (only when FillMass function is activated). — Act. App.Selector1 3: Application selection via the digital input (with digital input V1 / V2). — Act. App.Selector2 3: Application selection via the digital input (with digital input V3 / V4).
Active Mode	Select switching properties for the digital input. — Active High: Normally open — Active Low: Normally closed
Delay Time	Selection of delay time for suppressing EMC faults on the digital input.







7.5.9 Menu: Process Alarm

Menu / parameter	Description
Process Alarm	
Clear Alarm History	Reset of the alarm history.
...Group Masking	Selection of submenu "...Group Masking" using  .
...Alarm Limits	Selection of submenu "...Alarm Limits" using  .
Process Alarm / ...Group Masking	
Maintenance Required	Alarm messages are divided into groups.
Function Check	If masking is activated for a group (On), no alarm is issued.
Out Of Specification	For further information, see chapter 'Diagnosis / error messages' on page 93.
Process Alarm / ...Alarm Limits	
...Application 1	Selection of submenu "...Application 1...8" using  .
...	The alarm thresholds can be set separately for each application.
Application 8	
Process Alarm / ...Alarm Limits / ...Application 1...8	
Qm Massflow Min	Sets the minimum / maximum limit value for mass measurement. If the process value "Mass Flow [unit] " exceeds or falls below the limit value, an alarm is triggered.
Qm Massflow Max	
Qv@ Volumeflow Min	Set the minimum / maximum limit value for standard volume measurement. If the process value "Qv@ [Unit] " exceeds or falls below the limit value, an alarm is triggered.
Qv@ Volumeflow Max	
Tm Min	Sets the minimum / maximum limit value for sensor temperature. If the process value "Temperature [unit] " exceeds or falls below the limit value, an alarm is triggered.
Tm Max	

7.5.10 Menu: Communication

Menu / parameter	Description
Communication	
...HART	Selection of submenu "...HART" using  .
Communication / ...HART	
Device Address	Select the HART device address (polling address). NOTICE The HART protocol has provisions for creating a bus with up to 15 devices (1 ... 15) or up to 64 devices (1 ... 63, since HART Rev. 6) Older HART Masters support only the following addresses: 0 ... 15. Here the connection setup (command 0) with each device is conducted through the polling address. Polling address 0 is the default setting
Curr.Out 31/32/Uco	Selection of the operating mode for current output 31 / 32 / Uco. — Disabled: The current output supports the HART multi-drop mode, the current output is fixed to 3.6 mA and no longer follows the selected process variable. The process variables can be transferred via the HART protocol. — Enabled: The current output transfers the selected process variables. In addition, the process variables can be transferred via the HART protocol.
HART Tag	Entry of a HART TAG number as unique identifier for the device. Alphanumeric, a maximum of 8 characters, upper case only, no special characters.
HART Long Tag	Entry of a HART TAG number as unique identifier for the device. Alphanumeric, maximum of 32 characters, ASCII
HART Descriptor	Entry of a HART descriptor. Alphanumeric, a maximum of 16 characters, upper case only, no special characters.
HART Message	Display of the alphanumeric TAG number.
HART Manuf. ID	Display of the HART manufacturer ID. ABB = 26
HART Device ID	Display of the HART device ID.
HART Find	Select whether the transmitter must respond to the HART command 73 (Find Device). — Off: The transmitter does not respond to command 73. — Once: The transmitter responds once to command 73. — Continuous: The transmitter always responds to command 73.
Last HART Command	Display of the most recently sent HART command.



7.5.11 Menu: Diagnostics

Menu / parameter	Description
Diagnostics	
...Diagnosis Control	Selection of submenu "...Diagnosis Control" using  .
.....Diagnosis Values	Selection of submenu ".....Diagnosis Values" using  .
.....Simulation Mode	Selection of submenu ".....Simulation Mode" using  .
...Output Readings	Selection of submenu "...Output Readings" using  .
...SensorCheck	Selection of submenu "...SensorCheck" using  .
...Alarm Simulation	Selection of submenu "...Alarm Simulation" using  .
Diagnostics / ...Diagnosis Control	
Preset Maint. cycle	Sets the service interval. After the maintenance interval has expired, the corresponding error message "Maintenance interval is reached" is set. The setting "0" deactivates the maintenance interval.
Maint. Remain. Time	Time remaining in the maintenance interval until the error message "Maintenance interval is reached" is set.
Start New Cycle	Resetting of the maintenance interval. The service interval is reset to the value set in "Preset Maint. cycle".
Diagnostics /Diagnosis Values	
Gas Temperature	Display of the current measuring medium temperature in °C.
Transmitter Temp.FE	Display of the current temperature of the frontend board electronic unit in °C.
Diagnostics /Simulation Mode	
Simulation Switch	Manual simulation of measured values. After selecting the value to be simulated, a corresponding parameter is displayed in the menu "Diagnostics /Simulation Mode". The simulation value can be set here.
Off	
Curr.Out 31/32/Uco	The output values correspond to the simulated flowrate entered.
Curr.Out V1/V2 ¹⁾	Information "Configuration" appears in the lower line of the display.
Curr.Out V3/V4 ¹⁾	Only one measured value / output can be selected for simulation.
Dig.Out 41/42 State	After power-up / restart of the device, the simulation is switched off.
Dig.Out 41/42 Freq.	
Dig.Out 41/42 Pulse	
Dig.Out 51/52 State	
Dig.Out 51/52 Freq.	
Dig.Out V1/V2 State ¹⁾	
Dig.Out V3/V4 State ¹⁾	
Dig.In V1/V2 State ¹⁾	
Dig.In V3/V4 State ¹⁾	
Qm Massflow [unit]	
Qm Massflow [%]	
Qv@ Vol.flow [unit]	
Qv@ Vol.flow [%]	
Temperature [unit]	
Temperature [%]	

1) Only with plug-in card present.

Menu / parameter	Description
Diagnostics / ...Output Readings	
Curr.Out 31/32/Uco	Display the current values and statuses of the listed inputs and outputs.
Curr.Out V1/V2 ¹⁾	
Curr.Out V3/V4 ¹⁾	
Dig.Out 41/42 Freq.	
Dig.Out 41/42 State	
Dig.Out 51/52 Freq.	
Dig.Out 51/52 State	
Dig.Out V1/V2 State ¹⁾	
Dig.Out V3/V4 State ¹⁾	
Dig.In V1/V2 State ¹⁾	
Dig.In V3/V4 State ¹⁾	

1) Only with plug-in card present.





Diagnostics / ...SensorCheck	
...Verify Fingerprint	Selection of submenu "...Verify Fingerprint" using  .
...Install Fingerprint	Selection of submenu "...Install Fingerprint" using  .

Diagnostics / ...SensorCheck / ...Verify Fingerprint	
Check	Fingerprint testing manual start. The process takes approx. 12 minutes. It must be ensured that during this time there is no flow through the sensor (e.g. by shutting off or sealing off).
Result	Read fingerprint status
Value TDC1	Read VeriMass parameters.
Value TDC2	Value TDC1: Temperature change TDC1
Value HDC1	Value TDC2: Temperature change TDC2
Value HDC2	Value HDC1: Heat emission change HDC1
	Value HDC2: Heat emission change HDC2

Diagnostics / ...SensorCheck / ...Install Fingerprint	
Determine	Create the commissioning fingerprint. The commissioning fingerprint is created by writing any value to this address. The process takes approx. 12 minutes. It must be ensured that during this time there is no flow through the sensor (e.g. by shutting off or sealing off).
Delete (New)	Delete the commissioning fingerprint. The commissioning fingerprint is deleted by writing any value to this address.

Diagnostics / ...Alarm Simulation	
Manual simulation of alarms / error messages.	
The simulated alarm is selected by setting the parameter to the corresponding error. See also chapter 'Diagnosis / error messages' on page 93.	
The error messages available depend on the plug-in cards present.	
The following error messages can be simulated:	
Off, Flow Mass Reached, Flow Volume Reached, Simulation Alarm, Flowrate to Zero, Maint. Cycle Time, Totalizer Stop, Totalizer Reset, Totalizer Rollover, Dev. not calibrated, NV defect on FEB, NV data defect, FEB not detected, FEB comm. error, Incompatible FEB, NV defect on MB, DO 41/42 Saturated, CO 31/32 Saturated, CO Vx/Vy Saturated, CO 31/32 Comm. Error, Option 1 Comm. Error, Option 2 Comm. Error, CO 31/32 Safety, CO 31/32 Not Calibr., CO V1/V2 Not Calibr., CO V3/V4 Not Calibr., Volt. Monitoring MB, ADC Failure FE, Elec. defect FE, Sensor Temp. Max., Elec.Temp.Max.FE, Sensor Meas. Failure, Sensor Power Max., Gas Temperature Max., Configuration Error, Volume@ overflow, Sensor Soiling, Volt. Monitor FEB	

7.5.12 Menu: Totalizer

Menu / parameter	Description
Totalizer	
...Operation	Selection of submenu "...Operation" using  .
...Reset Totalizer	Selection of submenu "...Reset Totalizer" using  .
...Preset Totalizer	Selection of submenu "...Preset Totalizer" using  .
...FillMass	Selection of submenu "...FillMass" using  .
Totalizer / ...Operation	
Start all Totalizer	Starts all counters.
Stop all Totalizer	Stops all counters.
Totalizer / ...Reset Totalizer	
All Totalizer	Resets all totalizers to zero.
Massflow Qm	Reset all mass totalizers to zero.
Volumeflow Qv@	Reset all standard volume totalizers to zero.
Totalizer / ...Preset Totalizer	
Massflow Qm	Input from meter readings (e.g. when replacing the transmitter).
Volumeflow Qv@	
Totalizer / ...FillMass	
Batch Process Value	Selection of process variable used during the filling process. — Off: Filler deactivated. — VolumeFlow@: Standard flow rate. — Mass Flow: Mass flow.
Preset Batch Total.	Sets the fill quantity using the selected unit. When the defined fill quantity is reached, the configured binary output is activated. NOTICE Before setting the fill quantity, the corresponding process value must be selected with the parameter "Batch Process Value".
Reset Cur.Batch Tot.	Resets the current fill quantity.
Start Batching	Manual start of the filling function. Alternatively, the digital input can be configured for starting / stopping the fill operation.
Current Batch Total	Display of the current fill quantity. Once a fill operation has been started, the quantity already filled is shown here. The totalizer restarts at zero for each fill operation initiated and then counts up to the set fill quantity.
Stop Batching	Manual stop of the filling function. Alternatively, the digital input can be configured for starting / stopping the fill operation.
Current Batch Counts	Display of the number of fill operations since the last reset.
Reset Batch Counts	Sets the parameter "Current Batch Counts" to zero.
...Quantity	Select the "...Quantity" submenu.

Menu / parameter	Description
Totalizer / ...FillMass / ...Quantity	
Mode	<p>Selection of overrun correction.</p> <p>Closing the fill valve takes some time and as a consequence the measuring medium is "overrun", even though the fill quantity has been reached and the contact for closing the valve actuated.</p> <p>—Auto: The overrun quantity is calculated by the transmitter automatically.</p> <p>—Manual: The overrun quantity must be determined manually and entered in the selected unit via the parameter "Quantity".</p>
Quantity	Manual input of the overrun quantity / display of the overrun quantity detected automatically by the transmitter.
Factor	<p>Sets the weighting of the last filling process during automatic calculation of the overrun quantity.</p> <p>The calculation is based on the following formula:</p> <p>New correction value = last correction value + (Factor x correction value during the last fill operation)</p> <p>— 0.0: No change to correction value.</p> <p>— 1.0: The correction value is immediately adjusted to the overrun quantity calculated during the last fill operation.</p>
Time	Sets the time for the overrun quantity correction after the fill valve is closed.

7.6 Software history

In accordance with NAMUR recommendation NE53, ABB offers a transparent and traceable software history.

Device software package FMT430 / FMT450 (device firmware package)				
Version	Issue date	Type of change	Description	Ordering number
01.00.07	3.2.2017	First publication	–	3KXF002044U0100_01.00.07

7.7 FillMass batch function Only for FMT450

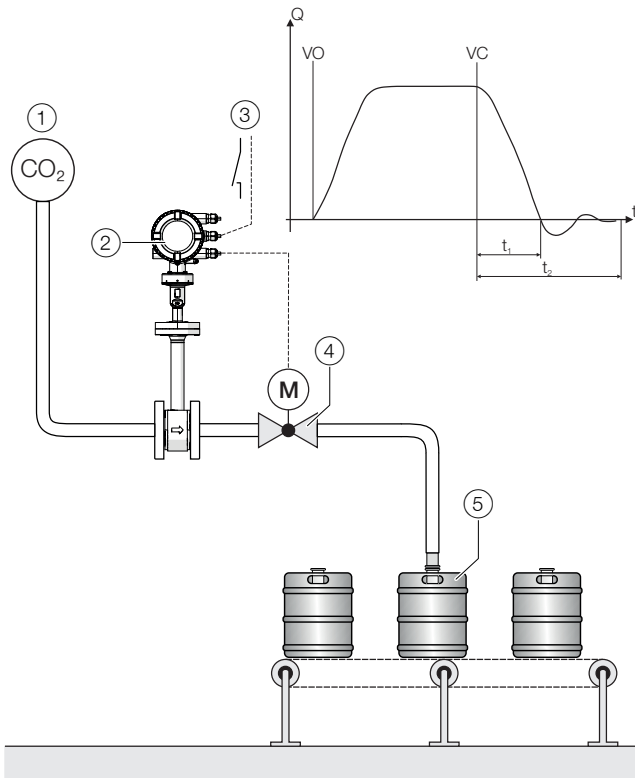

Fig. 58: Filling function FillMass (example CO₂ filling)

- ① Gas line (CO₂) ② Sensor ③ Fill start / stop (via digital input)
④ Fill valve ⑤ Fill container

Diagram legend

VO	Valve open (filling started)
VC	Valve closed (fill quantity reached)
t ₁	Valve closing time
t ₂	Overrun time

The integrated FillMass fill function allows filling processes to be recorded in > 3 seconds.

For this purpose, the filling quantity is given via an adjustable totalizer.

The fill function is controlled via the HART interface or via the digital input.

The valve is triggered via one of the digital outputs and closed again once the preset filling quantity is reached.

The transmitter measures the overrun quantity and calculates the overrun correction from this.

Additionally, the low flow cut-off can be activated if required.

7.7.1 Configuration

For the configuration of the fill mass function, the following steps must be performed:

1. The FillMass function must be active. See also the "Device Setup / ...Transmitter / ...Feature Settings / ..." menu.
2. One digital output must be configured as a binary output with the function "Batch End". See also the "Input/Output / ..." menu. As an option, one digital input (plug-in card) can be configured with the function "Start/Stop Batching" at the start of the filling process.
3. The parameters for the fill mass function must be configured. Also see the "Totalizer / ...FillMass / ..." menu.

NOTICE

During fast filling processes, the damping should be set to the minimum value to ensure the greatest possible accuracy of the fill quantity.

Also see the "Device Setup / ...Transmitter / ..." menu.

8 Diagnosis / error messages

8.1 Calling up the error description

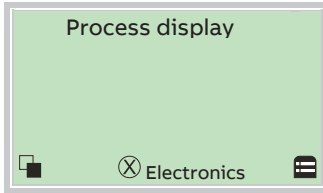

1. Use to switch to the information level (Operator Menu).

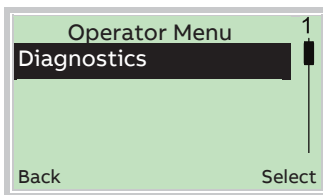

2. Use / to select the submenu "Diagnostics".
3. Confirm the selection with .

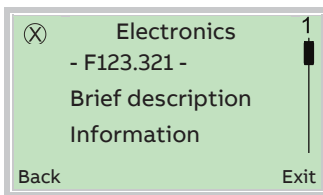

The error message is shown on the display according to priority. The first line shows the area in which the error has occurred. The second line shows the unique error number. It is made up of the priority (Fxxx) and the error position (.xxx). The next lines show a brief description of the error and information on how to remedy it. You absolutely need to scroll the display further to read the error message in more detail.

i NOTICE

For a detailed description of the error messages and information on troubleshooting, see the following pages.

8.2 General remarks

Errors encountered are itemized in tabular form on the following pages. The response of the transmitter on error detection is described therein.





The table lists all possible errors together with a description of their impact on the value of measurement variables, the properties of current outputs and the alarm output. If no entry is indicated in the table field, there is no effect on the measurement variable or no alarm signal for the particular output. The sequence of the errors in the table corresponds to the error priorities.













The first entry has the highest priority and the last has the lowest.

If multiple errors are detected simultaneously, the error with the highest priority determines the alarm condition of the measurement variable and the current output. If an error with a higher priority does not affect the measurement variable or the output status, the error with the next highest priority determines the status of the measurement variable and the output.

8.3 Overview

The counter readings and the states of the current outputs and the alarm output are represented by symbols; please see the table below.

Symbol	Description
	Counter stop
-	No change, current value
HOLD	The last "good" measured value is retained.
	Alarm (general)
	High alarm
	Low alarm

Priority	Error text	Process variables				Counter	Current output
		Qm [%, unit]	Qv [%, unit]	Density [g/cm ³]	Temperature [°C]		
98	No Frontend Board detected. Wrong connection. Defect Frontend.	0	0	1,293	20	-	
96	ADC Failure on Frontend Board.	0	0	1,293	20	-	
94	Safety Alarm Curr.Out 31/32	-	-	-	-	-	-
93	Sensor failure or disconnected.	0	0	1,293	20	-	
92	Electronics failFrontend Board.	0	0	1,293	20	-	
90	Sensor temperature out of range.	0	0	1,293	20	-	
88	FEB communication error.	0	0	1,293	20	-	
86	Curr.Out 31/32 com error.	-	-	-	-	-	 Only with current output 31 / 32 / Uco
84	NV data defect. Data storage irreparable.	0	0	1,293	20	-	
82	Incompatible Frontend Board.	0	0	1,293	20	-	
81	FEB voltages outside range.	-	-	-	-	-	
80	MB voltages outside range.	-	-	-	-	-	
78	Flowrate to zero	0	0	-	-	-	0
76	All totalizer stopp.	-	-	-	-		-
74	Totalizer reset. Reset of one or more Totalizers.	-	-	-	-	0	-

Priority	Error text	Process variables				Counter	Current output
		Qm [%, unit]	Qv [%, unit]	Density [g/cm ³]	Temperature [°C]		
72	Simulation is on! Simulating process/output value	-	-	-	-	-	-
70	An alarm is simulated.	-	-	-	-	-	-
59	Invalid Sensor configuration	-	-	-	-	-	
58	Sensor soiling detected.	-	-	-	-	-	-
55	Frontend temp. out of range.	-	-	-	-	-	-
57	Sensor temperature out of range.	-	-	-	-	-	HOLD, , Only with current output 31 / 32 / Uco
52	Curr.Out 31/32 is saturated.	-	-	-	-	-	HOLD, , Only with current output V1 / V2 or V3 / V4
51	Curr.Out V1/V2, V3/V4 saturated	-	-	-	-	-	 Only with current output V1 / V2
49	Option Card 1 com error.	-	-	-	-	-	 Only with current output V3 / V4
48	Option Card 2 com error.	-	-	-	-	-	-
47	Dig.Out 41/42 is saturated.	-	-	-	-	-	-
46	Dig.Out 51/52 is saturated.	-	-	-	-	-	-
45	Sensor heat emission limit.	-	-	-	-	-	-
44	Mass flowrate exceeds limits.	-	-	-	-	-	-
42	Medium temperat exceeds limits.	-	-	-	-	-	-
41	Std.Volume flow exceeds limits.	-	-	-	-	-	-
38	Sensor memory defective.	-	-	-	-	-	-
37	NV chips defect on Motherboard.	-	-	-	-	-	-
32	Curr.Out 31/32 not calibrated.	-	-	-	-	-	-
31	Curr.Out V1/V2 not calibrated.	-	-	-	-	-	-
30	Curr.Out V3/V4 not calibrated.	-	-	-	-	-	-
28	Display value is <1600h at Qmax.	-	-	-	-	-	-
26	Maintenance interval is reached	-	-	-	-	-	-
24	Device not calibrated.	-	-	-	-	-	

8.4 Error messages

Error number	Error text	Description	NAMUR classification
F098.011	No Frontend Board detected. Wrong connection. Defect Frontend.	Communication error to frontend board (FEB) of the sensor. No frontend board found, frontend board defective. — For remote mount design: check signal cable connection between sensor and transmitter — Restart the device — Replace frontend board — Contact ABB Service	Failure
F096.029	ADC Failure on Frontend Board.	AD-converter error in frontend board (FEB) of the sensor. EMC defects, frontend board defective — Check installation — Restart the device — Replace frontend board — Contact ABB Service	Failure
F094.021	Safety Alarm Curr.Out 31/32	Error in current output 31 / 32 / Uco — Check electrical connection current output 31 / 32 / Uco — Contact ABB Service	Failure
F093.033	Sensor failure or disconnected.	Electrical connection of the sensor or the thermal measuring element is defective. Sensor not connected, signal cable defective, sensor element defective. — For remote mount design: check signal cable connection between sensor and transmitter — Check thermal measuring element — Contact ABB Service	Failure
F092.030	Electronics failFrontend Board.	Electronics error in frontend board (FEB) of the sensor. EMC defects, frontend board defective — Check installation — Restart the device — Replace frontend board — Contact ABB Service	Failure
F088.012	FEB communication error.	Communication error to frontend board (FEB) of the sensor. Electro magnetic interference. — For remote mount design: check signal cable connection between sensor and transmitter — Restart the device — Contact ABB Service	Failure
F086.018	Curr.Out 31/32 com error.	Communication error to current output 31 / 32/ U _{CO} . Electro magnetic interference, faulty motherboard in transmitter. — Contact ABB Service	Failure
F084.010	NV data defect. Data storage irreparable.	Error in SensorMemory. Memory module defective — Contact ABB Service	Failure
F082.013	Incompatible Frontend Board.	Incompatible frontend board. The frontend board is not compatible with the motherboard in the transmitter. — Contact ABB Service	Failure
F081.041	FEB voltages outside range.	Frontend board power supply defective. Frontend board defective. — Check power supply — Replace frontend board — Contact ABB Service	Failure
F080.025	MB voltages outside range.	Motherboard power supply defective Faulty motherboard. — Contact ABB Service.	Failure

Error number	Error text	Description	NAMUR classification
C078.003	Flowrate to zero	External switch-off active via digital input. — Check status of digital input. — Check parameterization.	Functional check
C076.005	All totalizer stopp.	External totalizer switch-off active via digital input. — Check status of digital input. — Check parameterization.	Functional check
C074.006	Totalizer reset. Reset of one or more Totalizers.	Reset of one or more counters. — Check status of digital input. — Check parameterization.	Functional check
C072.002	Simulation is on! Simulating process/output value	Simulation mode is active. — Deactivate simulation mode in the "Diagnostics /Simulation Mode" menu.	Functional check
C070.026	An alarm is simulated.	The alarm simulation is active. — Deactivate alarm simulation in the "Diagnostics / ...Alarm Simulation" menu.	Functional check
S090.031	Sensor temperature out of range.	The temperature of the thermal measuring element is outside the permissible limits. Measuring medium temperature outside of the set alarm threshold or permissible limit values. — Check parameterization, see menu 'Menu: Process Alarm' on page 86 — Check process conditions, see chapter 'Process conditions' on page 14	Out of specification
S055.032	Frontend temp. out of range.	Device temperature outside of permissible limit values. — Check ambient temperature (see chapter 'Environmental conditions' on page 14)	Out of specification
S052.016	Curr.Out 31/32 is saturated.	Current output 31 / 32 overshoot. The flow has exceeded the set upper measuring range value. — Check the upper measuring range value Qv@ Max, Qm Max in the "Device Setup / ...Sensor" menu and correct if necessary.	Out of specification
S051.017	Curr.Out V1/V2, V3/V4 saturated	Current output V1 / V2, V3 / V4 (plug-in card) overshoot. The flow has exceeded the set upper measuring range value. — Check the upper measuring range value Qv@ Max, Qm Max in the "Device Setup / ...Sensor" menu and correct if necessary.	Out of specification
S049.019	Option Card 1 com error.	Communication error to plug-in card. — Check that the plug-in card is installed correctly.	Out of specification
S048.020	Option Card 2 com error.	— Replace plug-in card if necessary. — Contact ABB Service.	
S047.015	Dig.Out 41/42 is saturated.	The pulse rate or the frequency at the pulse output 41 / 42 is outside the permissible limits. — Check configuration of the parameters for the pulse output.	Out of specification
S046.042	Dig.Out 51/52 is saturated.	The pulse rate or the frequency at the pulse output 51 / 52 is outside the permissible limits. — Check configuration of the parameters for the pulse output.	Out of specification
S045.034	Sensor heat emission limit.	Heat emission limits of the measuring element up-scaled. Flow rate too high, incorrect measuring medium — Check the process conditions	Out of specification

Error number	Error text	Description	NAMUR classification
S044.000	Mass flowrate exceeds limits.	The mass flow is below or above the configured limit values "Qm Massflow Min" and "Qm Massflow Max". — Check the parameter settings in the "Process Alarm / ...Alarm Limits" menu and adjust if necessary. — Check mass flow.	Out of specification
S042.037	Medium temperature exceeds limits.	The measuring medium temperature is below or above the configured limit values "Tm Temperature Min" and "Tm Temperature Max". — Check the parameter settings in the "Process Alarm / ...Alarm Limits" menu and adjust if necessary. — Check measuring medium temperature.	Out of specification
S041.039	Std. Volume flow exceeds limits.	The standard volume flow is below or above the parameterized limit values "Qv@ Volumeflow Min" and "Qv@ Volumeflow Max". — Check the parameter settings in the "Process Alarm / ...Alarm Limits" menu and adjust if necessary. — Check volume flow rate.	Out of specification
M059.038	Invalid Sensor configuration	Parameterization (configuration) of the device is incorrect. — Check parameterization (configuration) — Contact ABB Service	Maintenance required
M058.040	Sensor soiling detected.	Thermal measuring element contaminated. — Check thermal measuring element and clean as needed (see chapter 'Maintenance' on page 99)	Maintenance required
M038.009	Sensor memory defective.	SensorMemory missing or defective — Check SensorMemory — Replace SensorMemory — Contact ABB Service	Maintenance required
M037.014	NV chips defect on Motherboard.	Memory module on the motherboard defective. — Contact ABB Service	Maintenance required
M032.022	Curr.Out 31/32 not calibrated.	Current output 31 / 32, Uco not calibrated. — Contact ABB Service.	Maintenance required
M031.023	Curr.Out V1/V2 not calibrated.	Current output (plug-in card) V1 / V2 or V3 / V4 not calibrated. — Check plug-in card and replace if necessary. — Contact ABB Service.	Maintenance required
M030.024	Curr.Out V3/V4 not calibrated.		
M028.007	Display value is <1600h at Qmax.	The current counter reading has exceeded the display resolution. — Check the unit setting for the mass counters / volume totalizers and adjust if necessary.	Maintenance required
M026.004	Maintenance interval is reached	Maintenance interval reached. — Perform maintenance work. — Start new maintenance interval in the "Diagnostics / ...Diagnosis Control" menu.	Maintenance required
M024.008	Device not calibrated.	Have device calibrated. — Contact ABB Service.	Maintenance required

9 Maintenance

9.1 Safety instructions

⚠ DANGER

Danger to life due to piping under pressure!

Sensors which may eject during installation or removal in piping remaining under pressure may pose a danger to life.

- Install or remove a sensor only if the piping is depressurized.
- As an alternative, use a pipe component with an integrated replacement device.

⚠ WARNING

Risk of injury due to live parts!

When the housing is open, contact protection is not provided and EMC protection is limited.

Before opening the housing, switch off the power supply.

⚠ CAUTION

Risk of burns due to hot measuring media.

The device surface temperature may exceed 70 °C (158 °F), depending on the measuring medium temperature!

Before starting work on the device, make sure that it has cooled sufficiently.

i NOTICE

Damage to components!

The electronic components of the printed circuit board can be damaged by static electricity (observe ESD guidelines).

Make sure that the static electricity in your body is discharged before touching electronic components.

Corrective maintenance work may only be performed by trained personnel.

- Before removing the device, depressurize it and any adjacent lines or containers.
- Check whether hazardous materials have been used as materials to be measured before opening the device. Residual amounts of hazardous material may still be present in the device and could escape when it is opened.

Within the scope of operator responsibility, check the following as part of a regular inspection:

- the pressure-carrying walls / lining of the pressure device
- the measurement-related function
- the leak tightness
- the wear (corrosion)

9.2 Flowmeter sensor

The flowmeter sensor is largely maintenance-free.

The following items should be checked annually:

- Ambient conditions (air circulation, humidity).
- Tightness of the process connections.
- Cable entries, cover gaskets and cover screws.
- Operational reliability of power supply, lightning protection and grounding.

9.3 Cleaning

When cleaning the exterior of meters, make sure that the cleaning agent used does not corrode the housing surface and the seals.

To avoid static charge, a damp cloth must be used for cleaning.

9.3.1 Clean measuring element.

It can be necessary to clean the thermal measuring element when measuring gases with damp contamination.

The cleaning interval depends on the degree of contamination of the measuring element and must be individually defined.

i NOTICE

Damage to the sensor due to improper cleaning!

- Do not clean the measuring element with hard objects (screwdrivers, tweezers or wire brushes).
- Do not clean the measuring element in an ultrasonic bath.
- Do not clean or dry the measuring element with pressurized air.

1. Switch off the power supply.
2. Disconnect electrical connections.
3. Disassemble the sensor from the pipe component or changing device, as described in chapter 'Installing the sensor' on page 22 and 'Installation of the sensor during operation' on page 24.

4. Carefully clean the measuring element with warm water or an alcohol solution using a soft brush or cotton swab.
5. Allow the sensor to dry or carefully dry with warm air.
6. Check that the gasket between the sensor and pipe component or welding adapter is clean and in good condition; if necessary replace it with a new gasket (O-Ring \varnothing 55 mm x 3 mm (2.16 x 0.12 inch)).
7. Install the sensor in the pipe component or changing device, as described in chapter 'Installing the sensor' on page 22 and 'Installation of the sensor during operation' on page 24.
8. Perform electrical connection (see chapter 'Electrical connections' on page 30).
9. Perform commissioning (see chapter 'Commissioning' on page 42).

9.4 Integrated hot tap fitting

Replace the O-ring gaskets

WARNING

Danger of injury due to improper maintenance!

Danger of injury due to leaking measuring medium during disassembly of the changing device with piping under pressure.

Before starting maintenance, depressurize the piping and rinse.

WARNING

Risk of fire due to the use of non-permissible grease for oxygen applications.

Only use permissible fitting grease for oxygen applications (e.g. Krytox GPL-226).

After approx. 100 sensor installation and disassembly procedures, the O-ring gaskets on the changing device must be replaced. If you are working with dusty, abrasive or aggressive measuring media, it may be necessary to replace these more frequently.

O-ring gaskets may only be replaced by the manufacturer's service department or by qualified personnel employed by the operator.

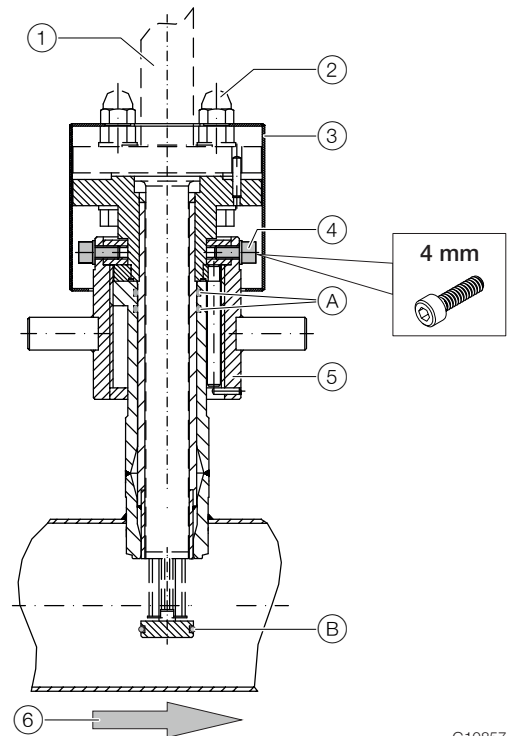

G10857

Fig. 59: Gaskets on the changing device

① Sensor ② Special screws ③ Protection cap ④ Fixing screw for union nut (4x) ⑤ Union nut ⑥ Flow direction

O-ring seals

Pos.	Quantity	Design
(A)	2	O-Ring \varnothing 36 x 3 mm (1,42 x 0,12 inch), Viton
(B)	1	O-Ring \varnothing 26 x 3 mm (1,02 x 0,12 inch), Viton

1. Disassemble the sensor (see chapter 'Installation of the sensor during operation' on page 24)
2. Loosen the fixing screws of the union nut and pull the guide tube out of the changing device. Clean the guide tube if necessary.
3. Replace both inside O-rings on the changing device and the O-ring of the guide tube. Lightly lubricate the O-rings as well as the threads of the union nut and slip ring of the guide tube.
4. Insert the guide tube in the changing device and tighten the fixing screws of the union nut as far as the limit stop in exactly the same position as during disassembly.
5. Verify correct installation by rotating the lock nut into measuring and disassembly positions.
6. Install the sensor (see chapter 'Installation of the sensor during operation' on page 24)

10 Repair

10.1 Safety instructions

⚠ WARNING

Risk of injury due to live parts!

When the housing is open, contact protection is not provided and EMC protection is limited.

Before opening the housing, switch off the power supply.

⚠ CAUTION

Risk of burns due to hot measuring media.

The device surface temperature may exceed 70 °C (158 °F), depending on the measuring medium temperature!

Before starting work on the device, make sure that it has cooled sufficiently.

i NOTICE

Damage to components!

The electronic components of the printed circuit board can be damaged by static electricity (observe ESD guidelines).

Make sure that the static electricity in your body is discharged before touching electronic components.

10.2 Spare parts

Repair and maintenance activities may only be performed by authorized customer service personnel.

When replacing or repairing individual components, use original spare parts.

i NOTICE

Spare parts can be ordered from ABB Service:

Please contact Customer Center Service acc. to page 2 for nearest service location.

10.3 Fuse replacement

i NOTICE

If the O-ring gasket is seated incorrectly or damaged, this may have an adverse effect on the housing protection class.

Follow the instructions in chapter 'Opening and closing the housing' on page 25 to open and close the housing safely.

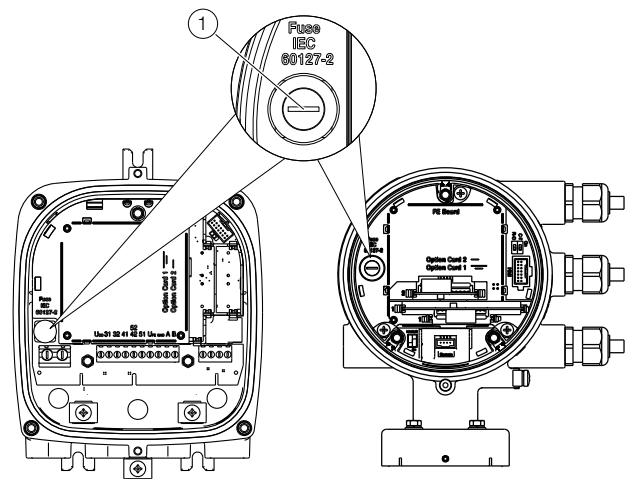

G11780-01

Fig. 60

① Fuse holder

There is a fuse in the transmitter terminal box.

Power supply	24 V DC	100 ... 240 V AC
Rated current	1,25 A	0,8 A
Rated Voltage	250 V AC	250 V AC
Design	Device Fuse 5 x 20 mm	
Breaking capacity	1500 A at 250 V AC	
Order number	3KQR000757U0100	3KQR000757U0200

Perform the following steps to replace the fuse:

1. Switch off the power supply.
2. Open the transmitter housing.
3. Pull out the defective fuse and insert a new fuse.
4. Close the transmitter housing.
5. Switch on the power supply.
6. Check that the device is working correctly.

If the fuse blows again on activation, the device is defective and must be replaced.

10.4 Replacing the LCD indicator

Dual-compartment housing

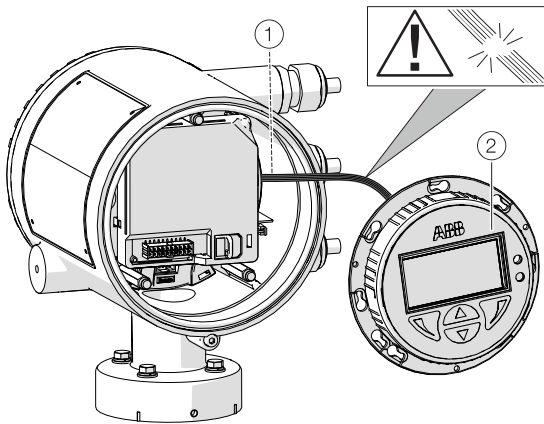

Single-compartment housing

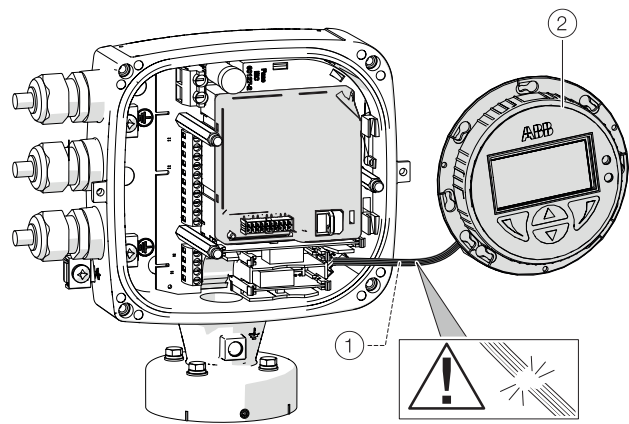

G12167

Fig. 61: Replacing LCD indicator (example)

① LCD indicator cable harness ② LCD indicator

NOTICE

If the O-ring gasket is seated incorrectly or damaged, this may have an adverse effect on the housing protection class.

Follow the instructions in chapter 'Opening and closing the housing' on page 25 to open and close the housing safely.

The LCD indicator can be replaced in the event of a malfunction.

Component	Order number
LCD indicator (HMI). Applicable for integral and remote mount design.	3KQZ407125U0100

Replace the LCD indicator as follows:

1. Switch off the power supply.
2. Unscrew / remove the cover.
3. Loosen the screws for the LCD indicator (only on integral mount design).
4. Remove the LCD indicator.
5. Pull the connector out of the electronic.
6. Plug in the connector of the new LCD indicator. Ensure that the cable harness is not damaged.
7. Insert the LCD indicator and screw on /replace the cover.
8. Switch on the power supply.

10.5 Replacing the frontend board

10.5.1 Integral mount design

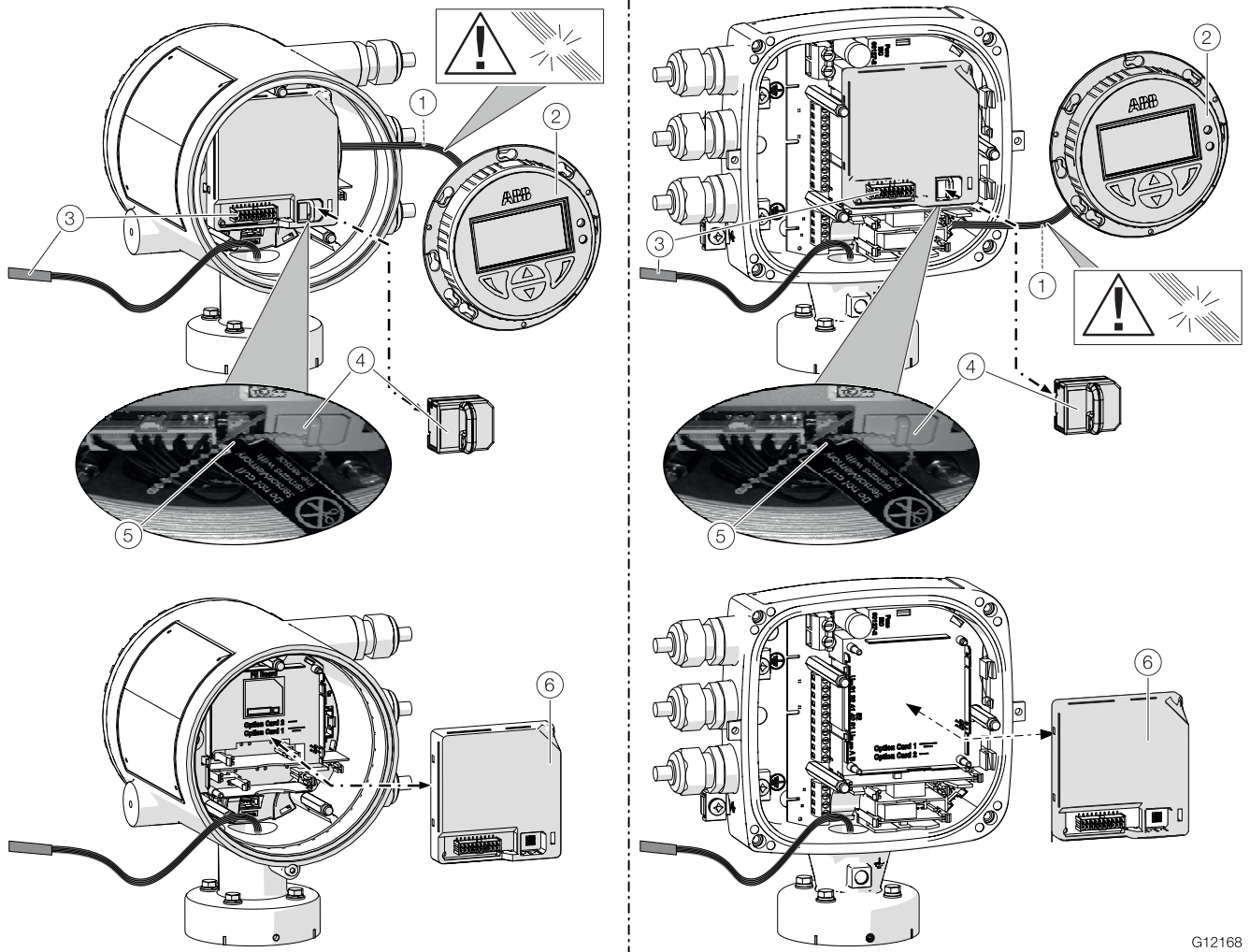

Fig. 62: Replacing LCD indicator and frontend board (example)

- ① LCD indicator cable harness ② LCD indicator ③ Sensor cable harness ④ SensorMemory ⑤ Cable retainer ⑥ Frontend board

i NOTICE

If the O-ring gasket is seated incorrectly or damaged, this may have an adverse effect on the housing protection class.

Follow the instructions in chapter 'Opening and closing the housing' on page 25 to open and close the housing safely.

In the event of a fault, the frontend board can be replaced on flowmeters with an integral mount design.

Component	Ordering number
Frontend board (FEB)	3KXF002810U0100

Replace the frontend board as follows:

1. Switch off the power supply.
2. Unscrew / remove the cover.
3. Remove the LCD indicator. Ensure that the cable harness is not damaged.
4. Pull the connector out of the sensor cable harness.
5. Pull out the SensorMemory.

i NOTICE

The SensorMemory is assigned to the sensor. The SensorMemory is therefore fastened to the sensor cable harness with a cable retainer.

Ensure that the SensorMemory remains with the sensor and cannot be lost!

6. Pull the faulty frontend board out forwards.
7. Insert new frontend board.
8. Attach connector from the sensor cable harness.
9. Attach the SensorMemory.
10. Insert the LCD indicator and screw on /replace the cover.

10.5.2 Remote mount design

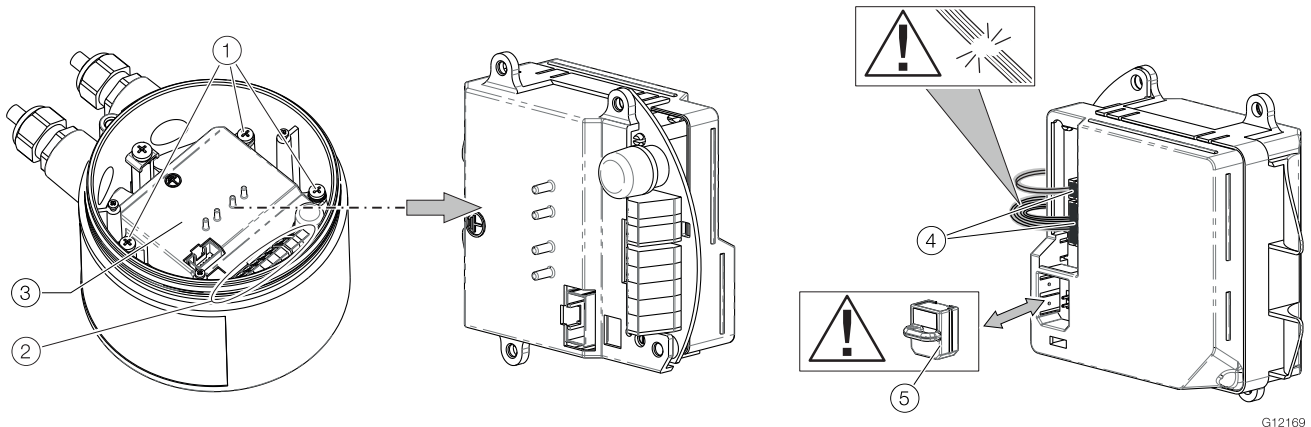

G12169

Fig. 63: Replacing the frontend board (flowmeter sensor)

① Fixing screw frontend board ② Connection terminals ③ Frontend board ④ Connectors for flowmeter sensor ⑤ SensorMemory

i NOTICE

If the O-ring gasket is seated incorrectly or damaged, this may have an adverse effect on the housing protection class. Follow the instructions in chapter 'Opening and closing the housing' on page 25 to open and close the housing safely.

The frontend board can be replaced in the event of a malfunction.

Component	Ordering number
Frontend board (FEB) (Slide-in remote)	3KXF002812U0100

Replace the frontend board as follows:

1. Switch off the power supply.
2. Unscrew / remove the cover.
3. Loosen the fixing screws (3x) at the frontend board.
4. Remove the faulty frontend board.
5. Pull the connector out of the sensor cable harness. Ensure that the cable harness is not damaged.
6. Pull out the SensorMemory.

i NOTICE

The SensorMemory is assigned to the sensor. Ensure that the SensorMemory remains with the sensor and cannot be lost!

7. Insert the SensorMemory into the new frontend board.
8. Connect the plug of the sensor cable harness.
9. Insert the new frontend board and secure it with the fixing screws (3x).
10. After powering up the power supply, the transmitter automatically replicates the system data from the SensorMemory.

10.6 Replacing the flowmeter sensor

WARNING

Risk of injury due to process conditions.

The process conditions, e.g. high pressures and temperatures, toxic and aggressive measuring media, can give rise to hazards when working on the device.

- Before working on the device, ensure that the process conditions do not pose any safety risks.
- If necessary, wear suitable personal protective equipment when working on the device.
- Depressurize and empty the device / piping, allow to cool and purge if necessary.

NOTICE

If the O-ring gasket is seated incorrectly or damaged, this may have an adverse effect on the housing protection class.

Follow the instructions in chapter 'Opening and closing the housing' on page 25 to open and close the housing safely.

NOTICE

The frontend board of the replacement sensor has a SensorMemorymodule.

The calibration data of the sensor is stored in the SensorMemory.

After powering up the power supply, the sensor automatically replicates the system data from the motherboard.

Replace the sensor as described below:

1. Switch off the power supply.
2. Unscrew / remove the cover.
3. Disconnect the signal cable (if necessary, remove the potting compound).
4. Install the new sensor in accordance with chapter 'Installation' on page 12.
5. Complete the electrical connection in accordance with chapter 'Electrical connections' on page 30.
6. Unscrew / set down the cover once again
7. After powering up the power supply, the sensor automatically replicates the system data from the motherboard.

10.7 Returning devices

Use the original packaging or a secure transport container of an appropriate type if you need to return the device for repair or recalibration purposes. Fill out the return form (see the Appendix) and include this with the device.

According to the EU Directive governing hazardous materials, the owner of hazardous waste is responsible for its disposal or must observe the following regulations for shipping purposes: All devices delivered to ABB must be free from any hazardous materials (acids, alkalis, solvents, etc.).

Please contact Customer Center Service acc. to page 2 for nearest service location.

11 Recycling and disposal

11.1 Dismounting

WARNING

Risk of injury due to process conditions.

The process conditions, e.g. high pressures and temperatures, toxic and aggressive measuring media, can give rise to hazards when dismantling the device.

- If necessary, wear suitable personal protective equipment during disassembly.
- Before disassembly, ensure that the process conditions do not pose any safety risks.
- Depressurize and empty the device / piping, allow to cool and purge if necessary.

Bear the following points in mind when dismantling the device:

- Switch off the power supply.
- Disconnect electrical connections.
- Allow the device / piping to cool and depressurize and empty. Collect any escaping medium and dispose of it in accordance with environmental guidelines.
- Use appropriate tools to dismantle the device, taking the weight of the device into consideration.
- If the device is to be used at another location, the device should preferably be packaged in its original packing so that it cannot be damaged.
- See the information in chapter 'Returning devices' on page 106.

11.2 Disposal

This product and its packaging are manufactured from materials that can be recycled by specialist recycling companies.

Bear the following points in mind when disposing of them:

- This product is not subject to WEEE Directive 2012/19/EU or relevant national laws (e.g. ElektroG in Germany).
- The product must be surrendered to a specialist recycling company. Do not use municipal garbage collection points. Only privately used products may be disposed of in the municipal garbage according to the WEEE directive 2012/19/EU
- If it is not possible to dispose of old equipment properly, ABB Service can take receipt of and dispose of returns for a fee.

NOTICE



Products that are marked with this symbol may not be disposed of through municipal garbage collection points.

12 Specification

NOTICE

The detailed device data sheet is available in the download area at www.abb.com/flow.

13 Additional documents

NOTICE

All documentation, declarations of conformity, and certificates are available in ABB's download area.

www.abb.com/flow

Trademarks

® HART is a registered trademark of FieldComm Group, Austin, Texas, USA

® Kalrez and Kalrez Spectrum™ are registered trademarks of DuPont Performance Elastomers.

™ Viton is a DuPont de Nemours trademark

14 Appendix

14.1 Return form

Statement on the contamination of devices and components

Repair and / or maintenance work will only be performed on devices and components if a statement form has been completed and submitted.

Otherwise, the device / component returned may be rejected. This statement form may only be completed and signed by authorized specialist personnel employed by the operator.

Customer details:

Company: _____
 Address: _____
 Contact person: _____ Telephone: _____
 Fax: _____ E-Mail: _____

Device details:

Typ: _____ Serial no.: _____
 Reason for the return/description of the defect: _____

Was this device used in conjunction with substances which pose a threat or risk to health?

Yes No

If yes, which type of contamination (please place an X next to the applicable items)?

Biological	<input type="checkbox"/>	Corrosive / irritating	<input type="checkbox"/>	Combustible (highly / extremely combustible)	<input type="checkbox"/>
Toxic	<input type="checkbox"/>	Explosiv	<input type="checkbox"/>	Other toxic substances	<input type="checkbox"/>
Radioactive	<input type="checkbox"/>				

Which substances have come into contact with the device?

1. _____
 2. _____
 3. _____

We hereby state that the devices / components shipped have been cleaned and are free from any dangerous or poisonous substances.

 Town/city, date

 Signature and company stamp

Notes

Notes

Notes



ABB Limited**Measurement & Analytics**

Howard Road, St. Neots
Cambridgeshire, PE19 8EU
UK

Tel: +44 (0) 870 600 6122

Fax: +44 (0)1480 213 339

Mail: enquiries.mp.uk@gb.abb.com

ABB Inc.**Measurement & Analytics**

125 E. County Line Road
Warminster, PA 18974
USA

Tel: +1 215 674 6000

Fax: +1 215 674 7183

abb.com/flow

ABB Automation Products GmbH**Measurement & Analytics**

Dransfelder Str. 2
37079 Goettingen
Germany

Tel: +49 551 905-0

Fax: +49 551 905-777

Mail: vertrieb.messtechnik-produkte@de.abb.com

We reserve the right to make technical changes or modify the contents of this document without prior notice. With regard to purchase orders, the agreed particulars shall prevail. ABB does not accept any responsibility whatsoever for potential errors or possible lack of information in this document.

We reserve all rights in this document and in the subject matter and illustrations contained therein. Any reproduction, disclosure to third parties or utilization of its contents in whole or in parts – is forbidden without prior written consent of ABB.

© ABB 2017

All rights reserved.

3KXF421015R4201